

Defense Logistics Agency



Religious Supply

Table of Contents

| | |
|--|---|
| Quick Start Guide | Islamic Items |
| POCs | Books and Literature |
| Chaplain Kits | Clothing |
| Pendants, Medals, Beads | Jewish Items |
| Christian Items | Books and Literature |
| Books and Literature | Candles and Accessories |
| Candles and Accessories | Clothing |
| Vestments and Altar Linens | Seasonal Items |
| Metalware | Kosher Wine |
| Seasonal Items | FAQ |
| Communion Supplies | AAC |
| Field Items | |
| Furniture Items | |

Quick Start Guide

1. Sign in or create a [FedMall](#) account (you will need to know your DoDAAC)
 - a. Instructions for how to create a FedMall account can be found at: <http://www.dla.mil/Info/FedMall/FedMallBuyers/>
 2. Search for the item in the catalog using the NSN **without** the dashes
 3. Select the item and place in shopping cart (you must do this to get the most current prices)
4. Once finished shopping submit the shopping cart to your authorized Government Purchase Cardholder. If using your supply section provide the NSN and current prices to your designated POC

****Follow all local procedures for making purchases**

POCs

[The Office of the DLA Chaplain](#)

DLAChaplain@dla.mil

[Chaplain \(COL\) Thomas Brooks](#)

DLA Chaplain

[SFC Joshua Potts](#)

Religious Affairs NCO

Customer Account Specialists (CAS) Supporting Ecclesiastical Supplies and Religious Rations

[Christine McCann](#), CAS

Defense Logistics Agency, Troop Support, Clothing and Textile

Phone: (445) 737-8300 DSN: (392) 737-8300





[Mr. Joe Zanolle](#), CAS

Defense Logistics Agency, Troop Support, Rations

Phone: (445) 737-8367 DSN: (392) 737-8367

Chaplain Kits





[Table of Contents](#)







| Item | NSN | U/I | Description | Photo |
|-----------------------------------|------------------|-----|--------------------------------------|---|
| Chaplain's Kit, Consumable | 9925-01-326-2855 | KT | Also called the Resupply Kit |  |
| Chaplain's Kit, Catholic, Min Ext | 9925-01-452-1131 | KT | For Catholic Lay Leaders |  |
| Chaplain's Kit, Christian | 9925-01-305-3411 | KT | For Christian and Catholic Chaplains |  |
| Chaplain's Kit, Jewish | 9925-01-326-2856 | KT | For Jewish Chaplains |  |





| | | | | |
|-----------------------------------|------------------|----|--|---|
| Chaplain's Kit, Islamic | 9925-01-464-8618 | KT | For Muslim Chaplains |  |
| Chaplain's Kit, Islamic, Min Ext | 9925-01-464-8683 | KT | For Muslim Lay Leaders |  |
| Chaplain's Kit, Orthodox | 9925-01-463-8428 | KT | For Orthodox Chaplains |  |
| Chaplain's Kit, Orthodox, Min Ext | 9925-01-452-1129 | KT | For Orthodox Lay Leaders |  |
| Bag, Chaplain's Kit (OCP) Carrier | 9925-01-672-5333 | EA | Replacement carrier for Chaplain Kits |  |
| Carrier, Chaplain's Kit, MARPAT | 9925-01-567-7285 | EA | Replacement carrier for Chaplain Kit Marine Corps users order the Army NSN for the kit and the MARPAT carrier separately |  |







Pendants, Medals, Beads







[Table of Contents](#)

| | | | | |
|-------------------------|------------------|----|--|---|
| Hamsa | 9925-01-542-8862 | EA | Material is a 3.32 inch non-magnetic/reactive 304 stainless steel; plain polished; size is 1 inch by 3/4 inch wide; Buddhist |  |
| Wheel of Life | 9925-01-544-7260 | EA | 1" wheel, stainless steel; Buddhist |  |
| Cross, Celtic w/ Chain | 9925-01-460-1053 | EA | Celtic cross, 1-1/2" high, on a 24" stainless steel chain; poly-bagged |  |
| Cross, Celtic w/o Chain | 9925-01-353-8788 | EA | Celtic cross, 1-1/2" high, poly-bagged |  |

| | | | | |
|-----------------------------|------------------|----|--|---|
| Cross, Orthodox, Triple Bar | 9925-01-451-2315 | EA | Small neck crosses; shall be a manufactured item or commercial equivalent; two inches long by one inch wide at main bar; 1/2 inch wide at top bar; 3/8 inch wide at bottom bar |  |
| Cross | 9925-01-542-8787 | EA | Material is a 3/32 inch non-magnetic/reactive 304 stainless steel; plain polished; size is 1-1/8 inches high by 11/16 wide |  |
| Pendant, Cross | 9925-01-544-7782 | EA | Material is a 3/32 inch non-magnetic/reactive 304 stainless steel; plain polished; size is 1 inch high by 11/16 inch wide |  |
| Cross, Plain | 9925-01-503-0248 | TF | Cross, Plain 2 1/4" in length, nickel plated metal, no chain. Non-precious lightweight metal, 25 crosses per box, minimum order quantity is one box of 25 crosses. |  |
| Celtic Cross | 9925-01-542-8789 | EA | Material is a 3/32 inch non-magnetic/reactive 304 stainless steel; plain polished; size is 1-1/8 inches high by 11/16 inch wide |  |
| Orthodox Cross | 9925-01-542-8863 | EA | Material is a 3/32 inch non-magnetic/reactive 304 stainless steel; plain polished; size is 1-3/8 inches high by 13/16 inch wide |  |



| | | | | |
|-------------------------------|------------------|----|---|---|
| Crucifix | 9925-01-353-8787 | EA | Devon #601m. Silver oxidized 2" crucifix. No chain. Nonprecious lightweight metal; cruciform includes a ring which enables it to be attached to a dog tag chain |  |
| Cross, Wood, w/necklace | 9925-01-451-2318 | EA | Approx. 3" wooden cross with 30" rawhide cord. |  |
| Cross wood, keychain | 9925-01-565-3096 | EA | Approx 1 7/8" wooden cross with keychain |  |
| Medal, Multi-Subject | 9925-01-460-1058 | EA | Made of anodized aluminum in bright finish; 4-way medal; brand name or equal |  |
| Medal, St. Barbara, w/o chain | 9925-01-465-5540 | EA | St. Barbara medal w/o chain, oxidized silver metal, Hirten number 1086 |  |

| | | | | |
|--|------------------|----|---|---|
| Medal, St. Barbara, with chain | 9925-01-465-5551 | EA | St. Barbara medal w/27" chain, oval shaped, oxidized silver metal, Hirten number 1086ch27 |  |
| Medal, St. Christopher & St. Sebastian | 9925-01-460-1065 | EA | Oxidized silver medal; St. Christopher is on one side and St. Sebastian is on the other side; both sides are in excellent detail; edges are highly burnish on both sides; brand name or equal |  |
| Medal, St. George | 9925-01-567-7401 | EA | St. George patron saint medal; oxidized silver; oval shaped; no chain; |  |
| Medal, St. Michael, w/o chain | 9925-01-465-6571 | EA | Without chain, St. Michael medal w/o chain, oval shaped, oxidized silver metal, Hirten number 1088 |  |
| Medal, St. Michael with chain | 9925-01-469-7335 | EA | St. Michael medal with 27" chain, oval shaped, oxidized silver metal; Hirten number 1088ch27 |  |
| Miraculous Medal | 9925-01-460-1062 | EA | Made of aluminum in bright finish; Brand name or equal |  |

| | | | | |
|------------------------------|------------------|----|---|---|
| Rosary, Black | 9925-01-460-0936 | EA | Machine mounted oval Rosary; length 21"; black beads with silver accents; brand name or equal; |  |
| Rosary, Plastic | 9925-01-353-9310 | EA | Malco rosary. Overall length 15.500 inches. Cross height 1.500 inches. Fiber hanger; includes instruction card. Plastic |  |
| Dhikr Prayer Beads, Black | 9925-01-464-9258 | EA | Dhikr prayer beads, black: n/cotton cord, color black, size not to exceed 14 inches |  |
| Dhikr Prayer Beads, White | 9925-01-464-9442 | EA | Dhikr prayer beads, white: n/cotton cord, color - white, size - not to exceed 14 inches |  |
| Star of David | 9925-01-542-8784 | EA | 1" star, stainless steel; Jewish |  |
| Crescent & Star | 9925-01-542-8938 | EA | Material is a 3.32 inch non-magnetic/reactive 304 stainless steel; plain polished; size is 1 inch by 1 inch wide; Islam |  |





Buddhist Items

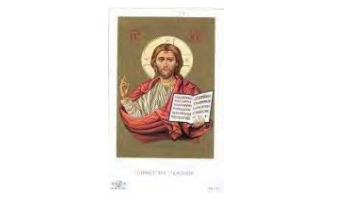

[Table of Contents](#)

| | | | | |
|---------------|------------------|----|--|---|
| Hamsa | 9925-01-542-8862 | EA | Material is a 3.32 inch non-magnetic/reactive 304 stainless steel; plain polished; size is 1 inch by 3/4 inch wide; Buddhist |  |
| Wheel of Life | 9925-01-544-7260 | EA | 1" wheel, stainless steel; Buddhist |  |

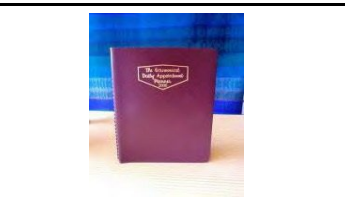

Christian Items





| | | | | |
|---|------------------|----|--|---|
| Bags, Protective, Communion, size 10" x 10" | 9925-01-460-0441 | EA | Bags to protect the fine original surfaces of communion ware and offering plates with specially treated flannel bags |  |
| Bags, Protective, Communion, size 13" x 15" | 9925-01-460-0200 | EA | Bags to protect the fine original surfaces of communion ware and offering plates with specially treated flannel bags |  |
| Bags, Protective, Communion, size 15" x 15" | 9925-01-460-0204 | EA | Bags to protect the fine original surfaces of communion ware and offering plates with specially treated flannel bags |  |
| Bags, Protective, Communion, size 18" x 18" | 9925-01-460-0437 | EA | Bags to protect the fine original surfaces of communion ware and offering plates with specially treated flannel bags |  |
| Basket, Collection, Reed | 9925-01-460-0229 | EA | Woven reed basket with reed handle; 9" x 13"; depth 4" 30" handle; fully lined |  |

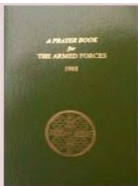
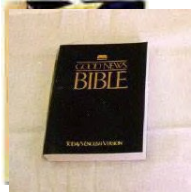

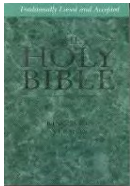
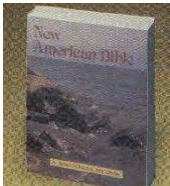

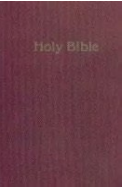

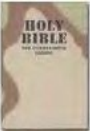
| | | | | |
|-----------------------|------------------|----|--|---|
| Burse, small | 9925-01-459-7455 | EA | Made of black imitation leather; gold cross on front; 3" x 2.5"; snap closure; black neck cord |  |
| Card, Icon of Christ | 9925-01-451-2316 | PG | Byzantine style; small icon of Christ; 15 each; made of heavy paper or card stock; 4-1/4 inch high and 2-3/8 inch wide; icon shall be Christ the teacher |  |
| Charcoal | 9925-01-459-3321 | BX | Will & Baumer #57704. Box of 100. 100 tablets to a box; sold by the box; self-lighting charcoal tablets |  |
| Ecumenical Planner | 9925-01-467-4277 | EA | Ecumenical calendar includes religious holidays, etc. Any orders after March 1 will be filled with the ecumenical planner for the following year. |  |
| Filler, Communion Cup | 9925-01-460-0105 | EA | Durable 16 oz. Squeeze bottle with measurement marks and non-drip spout; filler measures up to 100 cups |  |
| Incense, Benediction | 9925-01-459-3338 | BX | 1 lb. box; monastery brand or equal |  |



| | | | | |
|---------------------------------|------------------|----|--|---|
| Incense, Frankincense | 9925-01-459-3383 | BX | 1 lb. box; Cathedral candle company brand or equal |  |
| Liner, Plastic, Holy Water Font | 9925-01-459-4338 | EA | 5-1/2 inch diameter bowl |  |
| | | | | |

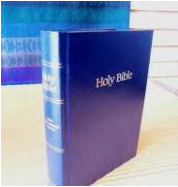

Books and Literature



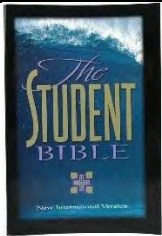

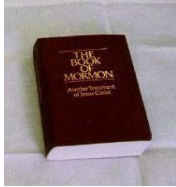
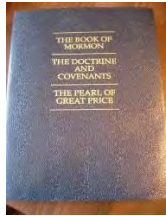
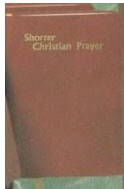
| | | | | |
|------------------------------|------------------|----|--|---|
| Armed Forces Prayer Book | 9925-01-448-6064 | EA | Armed forces prayer book. 3-1/2 x 5-1/2; flexible green cover; episcopal parish services #64-1755. Devotional prayers and services |  |
| Bible, Good News | 9925-01-384-1325 | EA | Good news bible; today's English version; softcover; 6"x4"; |  |
| Bible, Good News w/Deutero | 9925-01-384-1323 | EA | Good news w/Deuterocanonical/apocrypha; today's English version for Catholics |  |
| Bible, King James, Paperback | 9925-01-353-8784 | EA | ISBN 0-31090-416-1. Bible, King James version, English, 6.7" x 4.16" x 1.75"; soft cover; moisture proofing and soft cover. Color may be black, blue, maroon, brown or green |  |
| Bible, New American Catholic | 9925-01-353-8786 | EA | ISBN 0-89942-510-0. Size 6.5 x 4.5 inches. Holy bible new American catholic version; paperback; pocket size; large easy to read type; |  |

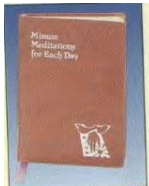
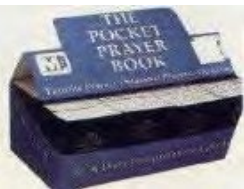

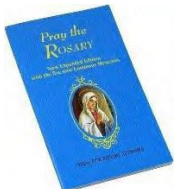

| | | | | |
|----------------------------------|------------------|----|---|---|
| Bible, New King James, Hardcover | 9925-01-459-7093 | EA | International bible society #711; traditional KJV text rendered in more contemporary language for church and personal use; hardcover; 5 3/4" x 8 1/2"; |  |
| Bible, NIV UCP | 9925-01-543-9454 | EA | Holy bible, international bible society, flexible vinyl cover with universal camouflage pattern, pocket sized approximately 4 inches by 6 inches |  |
| Bible, NIV, UCP | 9925-01-543-4497 | EA | International bible society, new international version bible, flexible vinyl cover, universal camouflage cover with pro deo et patria emblem, pocket sized approximately 4 inches by 6 inches. This item is for Army personnel only |  |
| Bible, NIV, Camouflage, Desert | 9925-01-459-7009 | EA | International bible society #193; flexible desert camouflage cover; pocket size; bible NIV |  |
| Bible, NIV, Camouflage, Woodland | 9925-01-353-8785 | EA | Holy Bible, new international version, 4" x 6"; woodland camouflage cover; moisture proofing and soft cover |  |
| Bible, NIV, Spanish, ACU | 9925-01-565-3051 | EA | Holy Bible, Spanish Translation; new international version, 4" x 6"; ACU cover; moisture proofing and soft cover |  |

| | | | | |
|-------------------------------------|------------------|----|--|---|
| Bible, New Testament, NIV, Woodland | 9925-01-452-7566 | EA | NIV New testament, military, woodland camouflage, 3 5/8"x5 1/4" |  |
| Bible, NIV, Family | 9925-01-478-7636 | EA | Family Bible, Ivory imitation leather, center-refer |  |
| Bible, NIV MARPAT | 9925-01-543-9459 | EA | Holy bible, international bible society, flexible vinyl cover with MARPT desert camouflage pattern, pocket sized approximately 4 by 6 inches |  |
| Bible, NIV, MARPAT | 9925-01-543-9461 | EA | Holy bible, international bible society, flexible vinyl cover with MARPT woodland camouflage pattern, pocket sized approximately 4 by 6 inches |  |
| Bible, NIV, Pew | 9925-01-462-5974 | EA | Navy hardcover published by Zondervan; 5 3/8" x 8 3/8"; published by international bible society; 5.5 x 8.5"; black (hardcover); international bible society no. 190 |  |
| Bible, Spanish, NIV | 9925-01-450-7158 | EA | Holy Bible, Spanish Translation, New International Version |  |





| | | | | |
|------------------------|------------------|----|---|---|
| Bible, Student, NIV | 9925-01-565-9941 | EA | the NIV student bible updated; new feature includes the guided tour highlights important passages that show the interconnectedness of the biblical narrative from genesis to revelation; 1457 pages; 6.24 inches x 8.78 inches x 1.43 inches |  |
| Bible, NRSV | 9925-01-459-7073 | EA | This version is ideal for everything from group bible studies to private devotions; miracles and parables of Christ section; topical reader helps; red hardcover; 5-1/2" x 8-3/4": brand name or equal: international bible society 896 |  |
| Book of Mormon | 9925-01-353-8790 | EA | Book of Mormon from the church of Jesus Christ of latter-day saints; 6 in. Lg; 4 in. W; 1 to 1-1/4 in. Thick; print on quality paper; moisture resistant soft cover |  |
| Book of Mormon | 9925-01-563-8410 | EA | Book includes the book of Mormon, doctrine and covenants, and pearl of great price, index, section of maps, pictures, and church history chronology. Large print, thumb-indexed, black. Bonded leather covers; 6-1/2 inches x 9-1/2 inches; large print |  |
| Book, Christian Prayer | 9925-01-459-6269 | EA | ISBN 089942-408-2; pocket edition; contains morning & evening prayer from 4 week altar & selected texts for the seasons & major feasts of the year; |  |

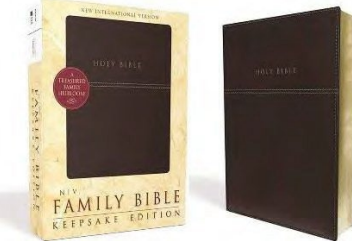
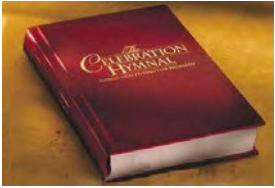
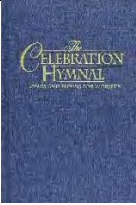
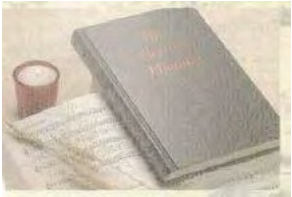

| | | | | |
|--|------------------|----|---|---|
| Book, Minute Meditations | 9925-01-459-6272 | EA | ISBN 089942-190-3. This book offers short scripture text, a practical reflection, and meaningful prayer for each day of the year; red flexible; 4" x 6-1/4", author; rev. Bede Naegele |  |
| Book, Pocket Prayer | 9925-01-460-1120 | EA | Regina press #1590; pocket prayer book for Catholics; 64 pages; English; 2" x 3"; |  |
| Book, the 4 th Man, English | 9925-01-459-7018 | EA | Communicate God's truth and Jesus' love to prisoners in a non-threatening way with this dramatically illustrated 32 page booklet; stories of Salomon the strong man, Jacob the con man, David the murderer and the 4 th man, Jesus the prisoner; strong masculine illustrations, easy-to-understand text - ENGLISH |  |
| Book, the 4 th Man, Spanish | 9925-01-459-7022 | EA | Communicate God's truth and Jesus' love to prisoners in a non-threatening way with this dramatically illustrated 32 page booklet; stories of Salomon the strong man, Jacob the con man, David the murderer and the 4 th man, Jesus the prisoner; strong masculine illustrations, easy-to-understand text - SPANISH |  |
| Booklet, Pray the Rosary | 9925-01-586-3671 | EA | color-blue; size-3-1/8x5; page quantity-64; binding feature- paperback |  |

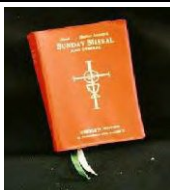

| | | | | |
|--------------------------|------------------|----|---|--|
| Bulletins, National | 9925-01-459-6426 | HD | Cokesbury #cc8-037778; regular size bulletins (8 1/2" x 11"); sold only in hundreds |  |
| Bulletins, Patriotic | 9925-01-459-6420 | HD | Regular size bulletins (8-1/2" x 11"); sold only in hundreds; patriotic cc8-061296 Cokesbury |  |
| Cards, Mass | 9925-01-460-0934 | BX | Barton cotton #mi-185; 100 cards w/envelopes; material - printed on matte coated paper featuring gold ink and gold foil accents; high quality white vellum envelopes included; 3-1/2: x 4-7/8"; sold only in boxes of 100; cover depicts "a mass offering" in black with gold picture of communion cup and bread plate; inside verse for deceased is "the holy sacrifice of the mass will be offered for the repose of the soul of----- " |  |
| Catholic Book of Prayers | 9925-01-459-6297 | EA | ISBN 089942-910-6; brown flexible cover; 4" x 6"; published by catholic book publishing co.; author Rev. Maurus Fitzgerald |  |

| | | | | |
|--|------------------|----|---|---|
| Certificate, Adult Baptism, Non-denominational | 9925-01-465-5714 | TD | Abington press #0-687-05354-4; certificate, adult baptism, non-denominational; Abington press #0-687-05354-4; foil stamped with envelope; package of 24 |  |
| Certificate, Marriage, Non-denominational | 9925-01-465-5707 | TD | Certificate, marriage, non-denominational; Abington press #0-687-05376-5; foil stamped with envelope; package of 24; |  |
| Certificate, Baptish, Catholic | 9925-01-460-0924 | FY | Front contains area for registering baptism; notation on back for recording religious events; 6"x9"; sold only in pads of 50 |  |
| Certificate, First Holy Communion | 9925-01-460-0920 | FY | Keepsake certificate with space for all pertinent information; 6"x9", sold only in pads of 50 |  |
| Certificate, Marriage, Catholic | 9925-01-460-0923 | HD | 6"x9"; Sold in pads of 100 |  |

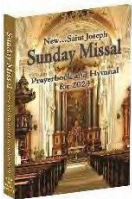
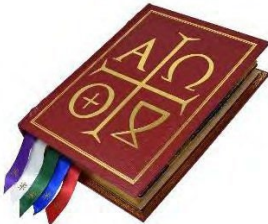
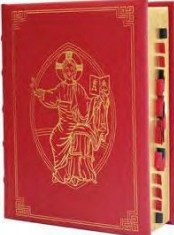

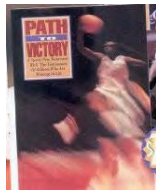

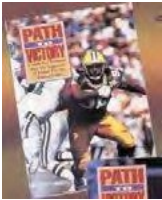
| | | | | |
|----------------------|------------------|----|---|--|
| Family Bible, NIV | 9925-01-586-3419 | EA | publisher-Zondervan; publication date-January 2007; suggested use-spiritual growth; size-9.5 width; 11.6 high; 2.6 deep; weight-6.06 lbs; paperedge-gold; Italian duo-tone burgundy; map index included and dictionary concordance included |  |
| Hymnal, Celebration | 9925-01-465-5904 | EA | The celebration hymnal, word publishing #3010144369. Standard edition, contemporary style hymns |  |
| Hymnal, Celebration | 9925-01-575-3684 | EA | this is a standard edition midnight blue paper back book. book weight is 2.28 pounds |  |
| Hymnal, Collegeville | 9925-01-459-6183 | EA | 480 seasonal, sanctoral, and sacrament hymns; responsorial psalmody; gospel acclamations and canticles; sequences; mass ordinary parts with Eucharistic acclamations; Latin music, chant; complete masses: 11 English and 2 Latin; funeral and wedding music; music scored satb when appropriate for the selection; attention to the use of inclusive language; complete set of indices: composer, author, meter, hymn, tune, title, biblical reference, and topics; selections referenced by number in margin; gray hardcover; 6"x9" |  |

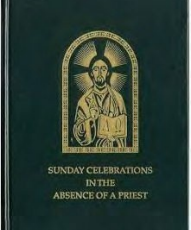



| | | | | |
|---|------------------|----|---|---|
| Hymnal, Word Music | 9925-01-465-5716 | EA | The hymnal for worship and celebration by word music, traditional style hymns, hardcover |  |
| Lectionary for Mass, Sundays | 9925-01-494-2012 | EA | ISBN 0-8146-2531-2; classic edition; liturgical press; volume i |  |
| Lectionary for Mass, Three-Vol. Weekday Set | 9925-01-494-2009 | EA | ISBN 0-8146-2564-9; classic edition; liturgical press; volume ii, iii and iv. 3 volume set- no.2883 |  |
| Missal, Catholic | 9925-01-354-7648 | EA | ISBN 0-89942-817-7; new St. Joseph Sunday missal, flexible cover, 7" x 4 1/2"; |  |
| Missal, St. Joseph Daily Missal Vol 1 | 9925-01-586-5660 | EA | Pages-1344; complete edition; volume 1, flexible vinyl cover, color-tan, dimensions-6.5 x 4.5 x 1.25 inches; weekday lectionary for mass; updated annually; |  |
| Missal, St. Joseph Daily Missal Vol 2 | 9925-01-586-5661 | EA | Complete edition, volume 2, 1344pages, flexible vinyl cover, color blue, dimensions-6.5 x 4.5 x 1.25 inches. Updated annually |  |





| | | | | |
|---|------------------|----|--|---|
| Missal, St. Joseph Sunday Missal | 9925-01-586-5678 | EA | Prayerbook And Hymnal Updated Annually; Flexible Laminated Cover; Pocket Sized; Complete Masses For All Sundays And Holy Days With The Easter Triduum |  |
| Missal, The Roman Missal, Third Altar Edition | 9925-01-603-3374 | EA | Deluxe Genuine Leather Altar Edition; Published For Use In The Dioceses Of The United States Of America Of America; Large; Easy To Read Type, 300 Full Color Illustrations; Cover-Leather; Color-Burgundy; Approximately 1456 Pages |  |
| Missal, The Roman Missal, Third CLOTH Altar Edition | 9925-01-603-3376 | EA | Deluxe Genuine Leather/Cloth Altar Edition; Published For Use In The Dioceses Of The United States Of America Of America; Large; Easy To Read Type, 300 Full Color Illustrations; Cover-Leather; Color-Burgundy; Approximately 1456 Pages |  |
| Missal, The Roman Missal, Third Chapel Edition | 9925-01-603-3378 | EA | Clothbound Chapel Edition; Published For Use In The Dioceses Of The United States Of America; Large, Easy To Read Type; 300 Full Color Illustrations; Five Ribbon Markers; Hard Cover; Color-Burgundy; Approximately 1456 Pages |  |
| New Test, NIV, Path to Victory, Basketball | 9925-01-459-7007 | EA | International bible society #1133. Features testimonies favorite verses of world-famous Christian athletes from major sports; strategies for studying god's word, including a 28-day reading plan; "we are not alone" spiritual growth section; gospel presentation; 5-1/4" x 8 "; |  |





| | | | | |
|--|------------------|----|--|--|
| New Test, NIV, Path to Victory, Football | 9925-01-459-7002 | EA | International bible society #1140. Features testimonies favorite verses of world-famous Christian athletes from major sports; strategies for studying god's word, including a 28-day reading plan; "we are not alone" spiritual growth section; gospel presentation; 5-1/4" x 8" |  |
| New Testament, Spanish | 9925-01-450-7157 | EA | International Bible society; paperback; NIV translation; 3.625" x 5.375 |  |
| Ritual for Laypersons | 9925-01-450-6804 | EA | ISBN 0-81462-150-3; paperback; English; published by liturgical press; 6.81" x 4.6" x 0.76"; |  |
| Sunday Celebrations In The Absence Of A Priest | 9925-01-586-5654 | EA | Sunday Celebrations In The Absence Of A Priest English And Spanish Page Quantity-432; Dimensions 7-1/4 X 10-1/2; 432 Pages |  |
| | | | | |







Candles and Accessories





| | | | | |
|--|-------------------------|-----------|---|---|
| <p>Advent Set, Oil, Refillable, 1-7/8"</p> | <p>9925-01-465-5604</p> | <p>SE</p> | <p>Lux Mundi #a10178; uses oil canisters, 3 purple/1 pink; 10" x 1-7/8" (wreath not included)</p> |  |
| <p>Advent Set, Oil, Refillable, 2-5/8"</p> | <p>9925-01-465-5671</p> | <p>SE</p> | <p>Lux Mundi #a10238; uses oil canisters, 3 purple/1 pink; 10" x 2-5/8" (wreath not included)</p> |  |
| <p>Advent Set, Oil, Refillable, 3-1/2"</p> | <p>9925-01-465-5679</p> | <p>SE</p> | <p>Lux Mundi #a10338; uses oil canisters, 3 purple/1 pink; 10" x 3-1/2" (wreath not included)</p> |  |
| <p>Wax Remover</p> | <p>9925-01-460-0227</p> | <p>EA</p> | <p>Plastic bottle, 8 oz.; removes candle wax from linens; brand name or equal</p> |  |





| | | | | |
|-----------------------------|------------------|----|--|---|
| Burner, Candle | 9925-01-478-7623 | EA | Emkay cp9; brass; 1 3/4" diameter for use with 9925-01-460-0212 (Emkay candle shell); candle burner, brass-tone finishing ring for candle shells that accept disposable candle fuel cartridges, 1.75 inches gives appearance of a normal candle follower |  |
| Candle Shell, 6" x 1- 7/8" | 9925-01-527-7364 | EA | Lux Mundi 6" x 1 7/8" shell |  |
| Candle Shell, 8" x 1- 7/8" | 9925-01-527-7365 | EA | Lux Mundi 8" x 1 7/8" shell |  |
| Candle Shell, 10" x 1- 7/8" | 9925-01-527-7366 | EA | Lux Mundi 10" x 1 7/8" shell |  |
| Candle Shell, 12" x 1- 7/8" | 9925-01-527-7368 | EA | Lux Mundi 12" x 1 7/8" shell |  |







| | | | | |
|----------------------------|------------------|----|---|---|
| Candle Shell, 12" x 2-5/8" | 9925-01-527-7370 | EA | Lux Mundi 12" x 2 5/8" shell |  |
| Candle Shell, 12" x 3-1/2" | 9925-01-527-7373 | EA | Lux Mundi 12" x 3 1/2" shell |  |
| Candle, Advent | 9925-01-459-2405 | SE | Will & Baumer Inc. #34295; set of 4, 3 purple 1 pink; 1 1/2"x16", 51% beeswax; |  |
| Candle, Baptismal | 9925-01-459-2390 | FY | 11/16" diameter x 10-3/4" h; decorated in full color with symbols of the baptismal font and water; white candle; individually boxed; 50 candles per case, sold by case only; will & Baumer no.71123 |  |
| Candle, Large Diameter | 9925-01-459-2538 | BX | Will & Baumer #30864; 51% beeswax; altar brand; 1 15/16"x24"; plain ends; white; 6 per box; |  |







| | | | | |
|---|------------------|----|---|---|
| Candle, Liquid, Insert | 9925-01-460-0172 | TS | 30 hour burn time; 3dozen/case; for 1 3/4" candle shell |  |
| Candle, Paschal, 1 15/16" x 39" Benedictine | 9925-01-461-2461 | EA | 51% beeswax candles |  |
| Candle, Paschal, 2 1/2" x 48" Benedictine | 9925-01-461-4626 | EA | 51% beeswax candles |  |
| Candle, Paschal, 3" x 60" Benedictine | 9925-01-461-2657 | EA | 51% beeswax candles |  |
| Candle, Paschal, 1 15/16" x 39" Ornamented | 9925-01-461-1040 | EA | 51% beeswax candles |  |







| | | | | |
|--|------------------|----|--|---|
| Candle, Paschal, 2 1/2" x 48" Ornamented | 9925-01-461-2459 | EA | 51% beeswax candles |  |
| Candle, Paschal, 3" x 60" Ornamented | 9925-01-461-1733 | EA | 51% beeswax candles |  |
| Candle, Paschal, 1 15/16" x 39" Plain | 9925-01-461-3990 | EA | 51% beeswax candles |  |
| Candle, Paschal, 2 1/2" x 48" Plain | 9925-01-461-2462 | EA | 51% beeswax candles |  |
| Candle, Paschal, 3" x 60" Plain | 9925-01-461-1732 | EA | 51% beeswax candles |  |
| Candle, Paschal, Refillable | 9925-01-465-5854 | EA | Refillable, paschal candle, 36"x2-5/8", oil burning, complete w/brass adornments |  |





| | | | | |
|--|------------------|----|--|---|
| Candle, Sanctuary, Liquid | 9925-01-460-0110 | DZ | 170-hour burn time; 1 dozen per case; sold only in dozens; fits 7 day globes |  |
| Candle, Vigil Lights, 10 hours/box of 48 | 9925-01-459-4106 | BX | White vigil lights; sold only in boxes; 10 hour burn time; 48 per box |  |
| Candle, Vigil Lights, 6 hours/box of 72 | 9925-01-459-4112 | BX | White vigil lights; sold only in boxes; 6 hour burn time; 72 per box |  |
| Candle, Votive Candles, Blue | 9925-01-459-4126 | BX | Non-glass containers; lightweight and compact; throw away containers; 500 per case, sold only in cases, blue color |  |
| Candle, Votive Candles, Ruby | 9925-01-459-4119 | BX | Non-glass containers; lightweight and compact; throw away containers; 500 per case, sold only in cases, ruby color |  |







| | | | | |
|---|------------------|----|--|---|
| Candle, Wedding Union Set | 9925-01-461-2456 | SE | Gold tone finish, cross shaped candle holder is a fitting representation for the beautiful hand-decorated 51% beeswax candles; center candle (has cross design with 2 interlocking gold rings) is 10" x 1-1/2"; 2 smaller side candles (gold bands around center of candle) are included; leaflet included |  |
| Candles, Congregation | 9925-01-473-4087 | HD | Candle, congregation, 100 candles with 100 drip protectors |  |
| Kit, Candlelight Service | 9925-01-459-2361 | KT | 120 candles and Bobaches, 1 pastor and 6 usher candles; |  |
| Candles, Long Burning, 1 1/8"x10 1/2"/box of 18 | 9925-01-459-4047 | BX | Plain ends; white; 1-1/8" diameter, 10-1/2" length; 18 per box, material - 51% beeswax; self-fitting |  |
| Candles, Long Burning, 1 1/8"15"/box of 12 | 9925-01-459-4043 | BX | Plain ends; white; 1-1/8" diameter, 15" length; 12 per box, material - 51% beeswax; self-fitting |  |

| | | | | |
|---|------------------|----|---|---|
| Candles, Long Burning, 7/8" x 16"/box of 18 | 9925-01-459-3519 | BX | Plain ends; white; 7/8" diameter, 16" length; 18 per box, material - 51% beeswax; self- fitting |  |
| Candles, Long Burning, 7/8" x 8"/box of 36 | 9925-01-459-3514 | BX | Plain ends; white; 7/8" diameter, 8" length; 36 per box, material - 51% beeswax; self- fitting |  |
| Candles, Long Burning, 7/8" x 12"/box of 36 | 9925-01-473-4051 | BX | Plain ends; white; 7/8" diameter, 12" length; 24 per box, material - 51% beeswax; self- fitting |  |
| Candles, Sterarine, 7/8" x 12"/box of 24 | 9925-01-473-4068 | BX | Candle, sterarine, 7/8x12, self-fitting ends, 51% beeswax |  |
| Candles, Table Altar, 1 1/2" x 12"; box of 12 | 9925-01-459-2375 | BX | 51% beeswax; plain ends; white; 1-1/2" diameter, 12" length; 12 per box; |  |
| Candles, Table Altar, 1 1/2" x 26"; box of 12 | 9925-01-459-2523 | BX | 51% beeswax; plain ends; white; 1-1/2" diameter, 26" length; 12 per box; |  |

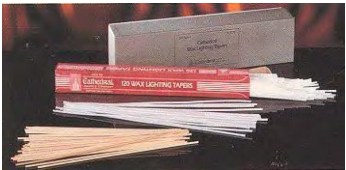
| | | | | |
|--|------------------|----|---|---|
| Candles, Table Altar, 1 ½" x 9"; box of 12 | 9925-01-473-4032 | BX | 51% beeswax; plain ends; white; 1-1/2" diameter, 9" length; 12 per box; |  |
| Follower, Candle, Glass | 9925-01-478-7624 | EA | Glass, draft protector, glass draft protector for use with candle shells that accept disposable candle fuel cartridges; 1.75 inches |  |
| Lighter, Candle | 9925-01-461-2457 | EA | Made of solid brass parts; highly polished; handle of selected hand-rubbed hardwood; taper slide is of jam-proof design: overall length is 18"; brand name or equal |  |
| Lighter, Candle w/Snuffer | 9925-01-476-1935 | EA | Candle lighter/snuffer, 36" length; solid high polished brass with dark wood handle |  |
| Lights, Sanctuary | 9925-01-462-6070 | DZ | 51% beeswax 8 day glass sanctuary lights; sold only in dozens |  |
| Liquid Paraffin Accessory Kit | 9925-01-465-6259 | KT | Liquid paraffin accessory kit including pump, quart bottle, pouring spout for paraffin |  |





| | | | | |
|---|------------------|----|---|---|
| Liquid Paraffin Disposable Can, 25 hr. | 9925-01-465-6380 | DZ | 25 hr. can; case of 12; for use with 1 7/8" shell; one time use only |  |
| Liquid Paraffin Disposable Can, 45 hr. | 9925-01-465-6386 | DZ | 45 hr. can; case of 12; for use with 2 5/8" shell; one time use only |  |
| Liquid Paraffin Disposable Can, 70 hr. | 9925-01-465-6569 | DZ | 70 hr. can; case of 12; for use with 3 1/8" shell; one time use only |  |
| Liquid Paraffin Refillable Can, 25 hour | 9925-01-465-6351 | EA | 25 hour, refillable can, fits 1-7/8" Shell, can only, paraffin not included |  |
| Liquid Paraffin Refillable Can, 45 hour | 9925-01-465-6358 | EA | 45 hour, refillable can, fits 2-5/8" Shell, can only, paraffin not included |  |
| Liquid Paraffin Refillable Can, 70 hour | 9925-01-465-6371 | EA | 70 hour, refillable can, fits 3-1/2" Shell, can only, paraffin not included |  |





| | | | | |
|--|------------------|----|---|---|
| Liquid Paraffin, 1 gallon | 9925-01-465-6260 | GL | Paraffin, 1 gallon |  |
| Liquid Paraffin, 12 quarts/case | 9925-01-465-6324 | BX | 99.4% pure paraffin, 12 quart, sold by case only |  |
| Sanctuary Light, Refillable | 9925-01-465-6229 | EA | 7-9 day refillable light uses liquid paraffin, includes brass top, wick & 5 additional wicks; 3-1/2"x6-1/4" |  |
| Socket, Candle, Liquid, Refillable, 1-1/2" | 9925-01-465-6225 | EA | Socket, candle, liquid, refillable, 1-1/2"; high polished brass |  |
| Socket, Candle, Liquid, Refillable, 7/8" | 9925-01-465-6223 | EA | Socket, candle, liquid, refillable, 7/8"; high polished brass |  |





| | | | | |
|----------------------------|------------------|----|---|---|
| Tapers, Wax Lighting | 9925-00-273-9561 | BX | 16-18"l; 0.125" diam; 120/bx; used to light candles; |  |
| Votive Glass, Small, Amber | 9925-01-462-5874 | DZ | 15 Hour; 2-1/2" high; sold by the dozen; color: amber; note: this item will hold both the 6 hour and 10 hour votive candles |  |
| Votive Glass, Small, Blue | 9925-01-462-5854 | DZ | 15 Hour; 2-1/2" high; sold by the dozen; color: Blue; note: this item will hold both the 6 hour and 10 hour votive candles |  |
| Votive Glass, Small, Ruby | 9925-01-462-5867 | DZ | 15 Hour; 2-1/2" high; sold by the dozen; color: Ruby; note: this item will hold both the 6 hour and 10 hour votive candles |  |
| Votive, Glass, Blue | 9925-01-460-0077 | EA | Dereume Glass #51, 10" tall, round bottom; blue |  |
| Votive, Glass, Crystal | 9925-01-460-0103 | EA | Dereume Glass #51, 10" tall, round bottom; crystal |  |



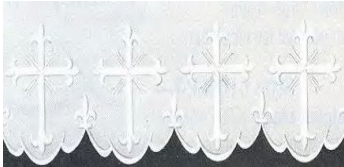

| | | | | |
|---------------------|------------------|----|---|---|
| Votive, Glass, Ruby | 9925-01-460-0075 | EA | Dereume Glass #51, 10" tall, round bottom; ruby |  |
| | | | | |







Vestments and Altar Linens

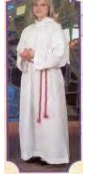





| | | | | |
|-----------------------------------|-------------------------|-----------|---|---|
| <p>Bookmark, Green/Purple</p> | <p>9925-01-465-5887</p> | <p>EA</p> | <p>Reversible, green and purple, 3-1/2"x36"</p> |  |
| <p>Cloth, Purificator, CG</p> | <p>9925-01-455-4580</p> | <p>EA</p> | <p>Camo green (OD), measures 12" x 18" w/ black cross.</p> |  |
| <p>Scarf, Chaplain's (OCP)</p> | <p>9925-01-672-8538</p> | <p>EA</p> | <p>Made of nylon oxford coated cloth, black cross embroidered, short (32" each side).</p> |  |
| <p>Chalice Pall</p> | <p>9925-01-460-0812</p> | <p>EA</p> | <p>Abbey #77I; 52%linen/48% ctn; 6-1/2" x 6- 1/2"; color: white; w/insert; beau veste no.77I; white;</p> |  |
| <p>Chalice Pall, Linen</p> | <p>9925-01-460-1079</p> | <p>EA</p> | <p>Abbott Hall #n875; 100% pure linen; white; 7" x 7"; 1" white cross embroidered on pall; square of stiffened linen over a Plexiglas base;</p> |  |





| | | | | |
|---------------------------|------------------|----|---|---|
| Corporal, White | 9925-01-460-0813 | EA | Abbey veste #74I, 52% linen/48% cotton; 21" x 21"; color: white; beau veste no.74I |  |
| Corporal, White Linen | 9925-01-460-1077 | EA | Abbott Hall #n873; 100% pure linen; white; 20" x 20"; 2" white cross embroidered on corporal; hemmed 1/2"; |  |
| Lavabo Towel | 9925-01-460-0810 | EA | Abbey #79I, 52% linen/48% cotton; 10" x 14"; color: white; beau veste no.79I |  |
| Lavabo Towel, Linen | 9925-01-460-1083 | EA | Abbott Hall #n874; 100% pure linen; white; 10" x 15"; 1" white cross embroidered on towel; |  |
| Linen, Altar, Embroidered | 9925-01-459-6552 | EA | White; 100% pure linen with embroidered hand scalloped design; linen is 120 thread, 4- 3/4 ounce weight; for proper measurement of altar cloth give actual width of mensa, front drop of altar cloth, when ordering yard goods allow 1 inch per yard for shrinkage; 52" width; priced per yard; brand name or equal; beau veste 1 |  |





| | | | | |
|--------------------------------------|------------------|----|---|---|
| Linen, Altar, White Silk Embroidered | 9925-01-460-3662 | EA | White 100% pure linen with embroidered hand scalloped design; linen is 120 thread, 4-3/4 ounce weight; for proper measurement of altar cloth give actual width of mensa, front drop of altar cloth, actual length of mensa top and side drops of altar cloth; when ordering yard goods allow 1 inch per yard for shrinkage; 52" width; 3-1/2" deep; priced per yard; brand name or equal; beau veste 1009 |  |
| Purificator, White | 9925-01-460-2480 | EA | Abbey #75I; 52% linen/48% ctn;; 12"x18", white; beau veste no.75I or equal |  |
| Purificator, White, Linen | 9925-01-460-1067 | EA | Abbott Hall #n871; 100% pure linen; white; 12" x 12"; white cross embroidered on pacificator; |  |
| Alb, Classic, size large | 9925-01-460-7324 | EA | 100% polyester; medium weight; color-white; top stitched back yoke; elastic in the waist in back; adjustable Velcro belt in front; inverted pleats on both sides; size: large; back length:60"; waist: 36-48"; sleeve length: 34"; fit height: 6'0"-6'3"; abbey no. 450 or equal |  |
| Alb, Classic, size medium | 9925-01-460-7325 | EA | 100% polyester; medium weight; color-white; top stitched back yoke; elastic in the waist in back; adjustable Velcro belt in front; inverted pleats on both sides; size: small; back length:56"; waist:32-40"; sleeve length:32"; fit height:5'6"-5'8"; abbey no. 450 or equal |  |

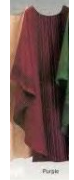

| | | | | |
|------------------------------|------------------|----|---|---|
| Alb, Classic, size small | 9925-01-460-7327 | EA | 100% polyester; medium weight; color-white; top stitched back yoke; elastic in the waist in back; adjustable Velcro belt in front; inverted pleats on both sides; size: small; back length:56"; waist:32-40"; sleeve length:32"; fit height:5'6"-5'8"; abbey no. 450 or equal |  |
| Alb, Classic, size x-large | 9925-01-460-7328 | EA | 100% polyester; medium weight; color-white; top stitched back yoke; elastic in the waist in back; adjustable Velcro belt in front; inverted pleats on both sides; size: x-large; back length: 62"; waist: 36-48"; sleeve length: 35"; fit height: over 6'3"; abbey no.450 or equal |  |
| Alb, Classic, size x-small | 9925-01-460-8860 | EA | 100% polyester; medium weight; color-white; top stitched back yoke; elastic in the waist in back; adjustable Velcro belt in front; inverted pleats on both sides; size: x-small; back length: 54"; waist: 30-38"; sleeve length: 31"; fit height: 5'3"-5'5"; abbey no. 450 or equal |  |
| Alb, Server, Deluxe, size 8 | 9925-01-460-6116 | EA | 100% polyester, medium weight; color-white; hood; size: 8; back length:40"; abbey no.207 or equal; cinctures sold separately |  |
| Alb, Server, Deluxe, size 10 | 9925-01-460-4578 | EA | 100% polyester, medium weight; color-white; hood; size: 10; back length: 40"; abbey no.207 or equal; cinctures sold separately. |  |





| | | | | |
|---|------------------|----|---|---|
| Alb, Server, Deluxe, size 12 | 9925-01-460-4584 | EA | 100% polyester, medium weight; color-white; hood; size: 12; back length:48"; abbey no.207 or equal; cinctures sold separately |  |
| Alb, Server, Deluxe, size 14 | 9925-01-460-4587 | EA | 100% polyester, medium weight; color-white; hood; size: 14; back length:52"; abbey no.207 or equal; cinctures sold separately |  |
| Alb, Server, Deluxe, size 16 | 9925-01-460-4589 | EA | 100% polyester, medium weight; color-white; hood; size: 16; back length: 56"; abbey no.207 or equal; cinctures sold separately |  |
| Alb, Server, Deluxe, size 18 | 9925-01-460-4590 | EA | 100% polyester, medium weight; color-white; hood; size: 20; back length:64"; abbey no.207 or equal; cinctures sold separately |  |
| Alb, Server, Deluxe, size 20 | 9925-01-460-4593 | EA | 100% polyester, medium weight; color-white; hood; size: 20; back length:64"; abbey no.207 or equal; cinctures sold separately |  |
| Cassock, Black, Altar Server, size 8 | 9925-01-460-2485 | EA | 65% polyester/35% combed cotton; color- black; snap closure; very full cut; deep pleats in back assure full flowing skirt; hidden opening in side pleats to reach inside pockets; size:8; back length:40"; abbey no.215s or equal |  |





| | | | | |
|---------------------------------------|------------------|----|--|---|
| Cassock, Black, Altar Server, size 10 | 9925-01-460-2486 | EA | 65% polyester/35% combed cotton; color- black; snap closure; very full cut; deep pleats in back assure full flowing skirt; hidden opening in side pleats to reach inside pockets; size:10; back length:44"; abbey no.215s or equal |  |
| Cassock, Black, Altar Server, size 12 | 9925-01-460-9318 | EA | 65% polyester/35% combed cotton; color- black; snap closure; very full cut; deep pleats in back assure full flowing skirt; hidden opening in side pleats to reach inside pockets; size:12; back length:48"; abbey no.215s or equal |  |
| Cassock, Black, Altar Server, size 14 | 9925-01-460-2489 | EA | 65% polyester/35% combed cotton; color- black; snap closure; very full cut; deep pleats in back assure full flowing skirt; hidden opening in side pleats to reach inside pockets; size:14; back length:52"; abbey no.215s or equal |  |
| Cassock, Black, Altar Server, size 16 | 9925-01-460-2487 | EA | 65% polyester/35% combed cotton; color- black; snap closure; very full cut; deep pleats in back assure full flowing skirt; hidden opening in side pleats to reach inside pockets; size:16; back length:56"; abbey no.215s or equal |  |
| Cassock, Black, Altar Server, size 18 | 9925-01-460-2488 | EA | 65% polyester/35% combed cotton; color- black; snap closure; very full cut; deep pleats in back assure full flowing skirt; hidden opening in side pleats to reach inside pockets; side:18; back length:60"; abbey no.215s or equal |  |
| Cassock, Black, Altar Server, size 20 | 9925-01-460-2493 | EA | 65% polyester/35% combed cotton; color- black; snap closure; very full cut; deep pleats in back assure full flowing skirt; hidden opening in side pleats to reach inside pockets; size:20; back length:64"; abbey no.215s or equal |  |





| | | | | |
|--|------------------|----|---|---|
| Chasuble/Stole Set, Charis, Candlelight | 9925-01-460-1338 | EA | Material: washable; crease-resistant charis cloth; tailored with full cut; rolled, tapered collar; includes a self-lined underlay stole; made in USA; each color will have its own NSN; brand name or equal; murphy charis chasubles 100c-12 |  |
| Chasuble/Stole Set, Charis, Gold Tone | 9925-01-460-1652 | EA | Material: washable; crease-resistant charis cloth; tailored with full cut; rolled, tapered collar; includes a self-lined underlay stole; made in USA; each color will have its own NSN; brand name or equal; murphy charis chasubles 100c-12 |  |
| Chasuble/Stole Set, Charis, Green | 9925-01-460-1647 | EA | Material: washable; crease-resistant charis cloth; tailored with full cut; rolled, tapered collar; includes a self-lined underlay stole; made in USA; each color will have its own NSN; brand name or equal; murphy charis chasubles 100c-12 |  |
| Chasuble/Stole Set, Charis, Purple | 9925-01-460-1332 | EA | Material: washable; crease-resistant charis cloth; tailored with full cut; rolled, tapered collar; includes a self-lined underlay stole; made in USA; each color will have its own NSN; brand name or equal; murphy charis chasubles 100c-12 |  |
| Chasuble/Stole Set, Charis, Red | 9925-01-460-1326 | EA | Material: washable; crease-resistant charis cloth; tailored with full cut; rolled, tapered collar; includes a self-lined underlay stole; made in USA; each color will have its own NSN; brand name or equal; murphy charis chasubles 100c-12 |  |
| Chasuble/Stole Set, Color: Hunter | 9925-01-460-1671 | EA | Material: wrinkle-resistant puulean polyester; chi rho embroidered on front; plain cord edged neckline; includes a self-lined underlay stole; made in the USA; each color will have its own NSN; brand name or equal; Murphy quick- ship 100p-01-9340 |  |





| | | | | |
|--------------------------------------|------------------|----|---|---|
| Chasuble/Stole Set, Color: Ivory | 9925-01-460-2200 | EA | Material: wrinkle-resistant puulean polyester; chi rho embroidered on front; plain cord edged neckline; includes a self-lined underlay stole; made in the USA; each color will have its own NSN; brand name or equal; Murphy quick- ship 100p-01-9340 |  |
| Chasuble/Stole Set, Color: Purple | 9925-01-460-2213 | EA | Material: wrinkle-resistant puulean polyester; chi rho embroidered on front; plain cord edged neckline; includes a self-lined underlay stole; made in the USA; each color will have its own NSN; brand name or equal; Murphy quick- ship 100p-01-9340 |  |
| Chasuble/Stole Set, Color: Red | 9925-01-460-2209 | EA | Material: wrinkle-resistant puulean polyester; chi rho embroidered on front; plain cord edged neckline; includes a self-lined underlay stole; made in the USA; each color will have its own NSN; brand name or equal; Murphy quick- ship 100p-01-9340 |  |
| Chasuble/Stole Set, Color: Rose | 9925-01-460-2215 | EA | Material: wrinkle-resistant puulean polyester; chi rho embroidered on front; plain cord edged neckline; includes a self-lined underlay stole; made in the USA; each color will have its own NSN; brand name or equal; Murphy quick- ship 100p-01-9340 |  |
| Cincture, Altar Server, Blue | 9925-01-461-3922 | EA | Material-braided cotton; 18" long w/distinctive knots at each end; each color will be a different NSN; color blue; brand name or equal; abbey 87 |  |

| | | | | |
|------------------------------------|------------------|----|---|---|
| Cincture, Altar Server, Gold | 9925-01-461-3982 | EA | Material-braided cotton; 18" long w/distinctive knots at each end; each color will be a different NSN; color gold; brand name or equal; abbey 87 |  |
| Cincture, Altar Server, Green | 9925-01-461-3985 | EA | Material-braided cotton; 18" long w/distinctive knots at each end; each color will be a different NSN; color green; brand name or equal; abbey 87 |  |
| Cincture, Altar Server, Natural | 9925-01-461-3978 | EA | Material-braided cotton; 18" long w/distinctive knots at each end; each color will be a different NSN; color natural; brand name or equal; abbey 87 |  |
| Cincture, Altar Server, Purple | 9925-01-461-3980 | EA | Material-braided cotton; 18" long w/distinctive knots at each end; each color will be a different NSN; color purple; brand name or equal; abbey 87 |  |
| Cincture, Altar Server, Red | 9925-01-461-3977 | EA | Material-braided cotton; 18" long w/distinctive knots at each end; each color will be a different NSN; color red; brand name or equal; abbey 87 |  |
| Cincture, Altar Server, White | 9925-01-461-3975 | EA | Material-braided cotton; 18" long w/distinctive knots at each end; each color will be a different NSN; color white; brand name or equal; abbey 87 |  |





| | | | | |
|--|------------------|----|--|---|
| Cincture, Rayon (Adult), Roman Purple | 9925-01-460-8906 | EA | Material-rayon; 4 yards in length of cord, tassel on both ends; individually packaged in a poly bag; color roman purple |  |
| Cincture, Monk's Knot (Adult), Gold Tone | 9925-01-460-8867 | EA | Material-braided cotton; length-48 inches; monk's knot on ends, contemporary style rope; individually packaged in poly bags; each color will be a different NSN; color gold; brand name or equal; abbey monk's knot cincture 85 |  |
| Cincture, Monk's Knot (Adult), Nat Green | 9925-01-460-8869 | EA | Material-braided cotton; length-48 inches; monk's knot on ends, contemporary style rope; individually packaged in poly bags; each color will be a different NSN; color natural green; brand name or equal; abbey monk's knot cincture 85 |  |
| Cincture, Monk's Knot (Adult), Purple | 9925-01-460-8864 | EA | Material-braided cotton; length-48 inches; monk's knot on ends, contemporary style rope; individually packaged in poly bags; each color will be a different NSN; color purple; brand name or equal; abbey monk's knot cincture 85 |  |
| Cincture, Monk's Knot (Adult), Red | 9925-01-460-8861 | EA | Material-braided cotton; length-48 inches; monk's knot on ends, contemporary style rope; individually packaged in poly bags; each color will be a different NSN; color red; brand name or equal; abbey monk's knot cincture 85 |  |





| | | | | |
|---|------------------|----|--|--|
| Cincture, Monk's Knot (Adult), White | 9925-01-460-8863 | EA | Material-braided cotton; length-48 inches; monk's knot on ends, contemporary style rope; individually packaged in poly bags; each color will be a different NSN; color white; brand name or equal; abbey monk's knot cincture 85 |  |
| Cincture, Monk's Knot (Adult), Natural | 9925-01-463-1792 | EA | Material-braided cotton; length-48 inches; monk's knot on ends, contemporary style rope; individually packaged in poly bags; each color will be a different NSN; color natural; brand name or equal; abbey monk's knot cincture 85 |  |
| Pulpit Gown, White Liberty, White Velvet, size lg long | 9925-01-460-8412 | EA | Medium weight textured polyester; color-white liberty adorned w/white velveteen plain panels and matching cording outlines side pleats; deep pleats in back assure full flowing skirt; double lined sleeves w/cuff for a bell effect sleeve; full precision fluting across shoulder and back gives a beautiful drape; size: large long; height 6'3" and up; chest: 46-48"; back length: 61"; sleeve: 36" |  |
| Pulpit Gown, White Liberty, White Velvet, size lg short | 9925-01-460-8414 | EA | Medium weight textured polyester; color-white liberty adorned w/white velveteen plain panels and matching cording outlines side pleats; deep pleats in back assure full flowing skirt; double lined sleeves w/cuff for a bell effect sleeve; full precision fluting across shoulder and back gives a beautiful drape; size: large short; height 6'-6'2"; chest: 46-48"; back length: 59"; sleeve: 35" |  |





| | | | | |
|---|-------------------------|-----------|---|---|
| <p>Pulpit Gown, White Liberty, White Velvet, size med long</p> | <p>9925-01-461-4525</p> | <p>EA</p> | <p>Medium weight textured polyester; color-white liberty adorned w/white velveteen plain panels and matching cording outlines side pleats; deep pleats in back assure full flowing skirt; double lined sleeves w/cuff for a bell effect sleeve; full precision fluting across shoulder and back gives a beautiful drape; size: medium long; height: 5'10"-5'11"; chest: 42-44"; back length: 57"; sleeve: 35"</p> |  |
| <p>Pulpit Gown, White Liberty, White Velvet, size small long</p> | <p>9925-01-461-4530</p> | <p>EA</p> | <p>Medium weight textured polyester; color-white liberty adorned w/white velveteen plain panels and matching cording outlines side pleats; deep pleats in back assure full flowing skirt; double lined sleeves w/cuff for a bell effect sleeve; full precision fluting across shoulder and back gives a beautiful drape; size: small long; height: 5'7"-5'7"; chest: 38-40"; back length: 53"; sleeve: 34"</p> |  |
| <p>Pulpit Gown, White Liberty, White Velvet, size small short</p> | <p>9925-01-461-4528</p> | <p>EA</p> | <p>Medium weight textured polyester; color-white liberty adorned w/white velveteen plain panels and matching cording outlines side pleats; deep pleats in back assure full flowing skirt; double lined sleeves w/cuff for a bell effect sleeve; full precision fluting across shoulder and back gives a beautiful drape; size: small short; height: 5'3"-5'5"; chest: 38-40"; back length: 51"; sleeve: 33"</p> |  |
| <p>Resurrection Set</p> | <p>9925-01-460-1131</p> | <p>EA</p> | <p>Resurrection set includes the following components: funeral pall, chasuble, overlay stole, material: washable polyester, silk and metallic gold yarn seven color Swiss embroidery of shell, flame, and water; one NSN for complete set (individual components not available separately); brand name or equal: Harbro 05</p> |  |

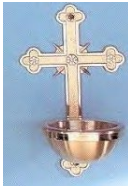



| | | | | |
|---------------------------------|------------------|----|--|---|
| Scapular | 9925-01-460-0929 | EA | A scapular in full color; Our Lady of Mount Carmel in cloth with brown silk braid; brand name or equal; Hirten 1520-05 |  |
| Stole Reversible | 9925-01-523-2740 | EA | Stole reversible; black on one side, white on the other; USA great seal embroidered at bottom with metallic gold thread; bottom of stole has fringe using same gold metallic thread; for use by male and female chaplains. |  |
| Stole, Reversible, Green/Purple | 9925-01-465-5898 | EA | Green/purple reversible stole, Abbott Hall number sp12 or equal |  |
| Stole, Reversible, Red/White | 925-01-465-5896 | EA | Red/white reversible stole, Abbott Hall #sp11 |  |
| | | | | |







Metalware



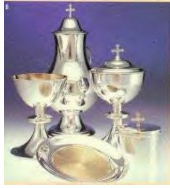

| | | | | |
|--|-------------------------|-----------|---|---|
| <p>Altar Set, Chapel Line, candlesticks only</p> | <p>9925-01-459-5719</p> | <p>PR</p> | <p>Brass and fine wood construction; 5 piece altar set can be bought as an ensemble or individual components; solid brass components are protected by urethane finish and set firmly on a hand polished fine grained walnut or oak base; high polish finish; one pair vase liners included in full set; the complete set and individual components will each have their own NSN; candlesticks rw-124br 8-1/4"h, 1- 1/8" socket; 4lbs/pr.; sold only in pairs; brand name or equal; artistic</p> |  |
| <p>Altar Set, Chapel Line, Cross w/Corpus</p> | <p>9925-01-478-7554</p> | <p>EA</p> | <p>Artistic #rw024br & rw2010; high polish brass cross w/corpus; wood base (walnut or oak); cross/corpus chapel line, solid brass and wood construction protected by a urethane finish, hand polished base 24 inches high, 12 inches wide, artistic rw024br or equal</p> |  |
| <p>Cross, Altar W/Corpus</p> | <p>9925-01-460-0938</p> | <p>EA</p> | <p>High polished brass; oven baked for durability; 17"h: 6" diameter base; with silver corpus; brand name or equal; Excelsis 240-133</p> |  |
| <p>Bell, Four, Hand</p> | <p>9925-01-459-5483</p> | <p>EA</p> | <p>Excelsis #1100-120; hand held; four bells; high polish gold finish.;</p> |  |







| | | | | |
|-----------------------------------|------------------|----|---|---|
| Bell, Single, Hand | 9925-01-459-5479 | EA | Hand held; single bell; satin bronze finish; 2-3/4" diameter, 6-1/4" height; regal no.25bl8 or equal |  |
| Bowl, Replacement, Holy Water | 9925-01-459-4325 | EA | Made of bronze; oven baked for durability; 5-1/2 inch diameter bowl; brand name or equal; Excelsis 2711-92 |  |
| Chalice and Paten | 9925-01-459-7307 | SE | Paten 5 3/4" X 6 1/2"; 4" Cup diameter; bright Gold plated finish; 16 oz. |  |
| Font, Holy Water, Aluminum | 9925-01-459-3723 | EA | Aluminum; oven baked for durability; with aluminum basins and plastic liners; 5-1/2" diameter bowl; back plate 7" x 12"; Excelsis no.2538-83b or equal |  |
| Font, Holy Water, Bronze, Chi Rho | 9925-01-459-3719 | EA | Bronze; oven baked for durability; with bronze basins and plastic liners; 5-1/2" diameter bowl; back plate 3-1/2" x 10"; textured surface back plate in antique black finish with a Chi Rho symbol; Excelsis no.2518-83b or equal |  |
| Font, Holy Water, Bronze | 9925-01-459-3726 | EA | Bronze; high polish; oven baked for durability; with bronze basins and plastic liners; 5-1/2" diameter bowl; back plate 7-1/2" x 16"; Excelsis no.242-83c or equal |  |







| | | | | |
|-----------------------------------|------------------|----|--|---|
| Candelabra, Altar, 7-Light, Brass | 9925-01-476-1934 | EA | Candelabra, 7 light; 7" base, height 18"; adjustable arms; 7/8" sockets; high polished and clear lacquered brass; Koley no. K482 or equal. |  |
| Candlestick, Advent/Pascal | 9925-01-465-5900 | EA | Ziegler #3981; brass advent wreath and paschal candlestick; removable top; 23 1/2" diameter; base 12"; height 50"; all brass, satin finish, |  |
| Candlestick, Altar, Bronze, 3.5" | 9925-01-461-4583 | EA | Made of bronze; combined satin and textured surfaces; 1-1/2" sockets and Plexiglas wax protectors; height 3-1/2" diameter; round base; sold as each; coordinates with candlestick, standing, processional 25 fc 15; brand name or equal; regal s-25 c-15 |  |
| Candlestick, Altar, Bronze, 4" | 9925-01-461-1024 | EA | Made of bronze, tripod base with textured surface of antique black finish; 1-1/2" socket has a smooth brass finish and Plexiglas wax protectors: stands 4" high with a 5-1/2" diameter base, sold as each |  |
| Candlestick, Paschal | 9925-01-461-2655 | EA | Made of brass, satin finish; oven baked for durability; 1-15/16" socket; 48" high with 12" x 12" 4 legged base; smooth shaft with center decorated nodule that has 3 rows of raised nodules; coordinates with candlestick; altar 384-l; brand name or equal; Excelsis 384-17 |  |





| | | | | |
|-------------------------------------|------------------|----|--|---|
| Candlestick, Standing, Processional | 9925-01-461-1043 | EA | Made of bronze; processional unit has removable top section encased with clear vinyl for prevention of tarnishing; 1-1/2"; diameter socket; designer base 12" diameter; height 44"; smooth shaft. Coordinates with candlestick, altar s-25 c 15; brand name or equal; regal 25 fc 15 |  |
| Candlestick, Standing, Processional | 9925-01-461-4605 | EA | Made of bronze; processional unit has removable top section encased with clear vinyl for prevention of tarnishing; 1-1/2" diameter socket; designer base 12" diameter; height 44"; smooth shaft; partial textured shaft and base of antique black finish. Coordinates with candlestick, altar 76 c 20; brand name or equal; regal 24 fc 10 |  |
| Cross, Processional w/St. & Corpus | 9925-01-460-1047 | EA | High polished brass; oven baked for durability; 92"h; 11-1/2" diameter base; cross has silver corpus; brand name or equal; Excelsis 240-207 |  |
| Ciboria, Stacking | 9925-01-459-7435 | SE | Gold finish; deep unit, stacking ciboria with handle; 4 piece set-3 ciboria and 1 cover; diameter 5"; height 8-3/4"; capacity 750 each; brand name or equal; Alвити Creations 43000 |  |
| Ciborium | 9925-01-459-7262 | EA | 7-1/2" height; 5" diameter; gold plated; bright polished finish; 500 host capacity based on 1-1/8" host; brand name or equal; Koley k596 |  |





| | | | | |
|--|------------------|----|--|---|
| Communion Set, Chapel, Catholic | 9925-01-466-4751 | SE | Communion set, catholic, silver-plated bronze, set includes chalice, ciborium, flagon, host box, and paten, artistic, traditional American design, number asa-903 and asa-915 or equal |  |
| Cruets, Glass | 9925-01-459-9718 | PR | Crystal glass cruets; 8oz.; 7"h; brand name or equal; Alviti Creations cb-4 |  |
| Set, Cruet w/Chrome Tray | 9925-01-459-9599 | SE | The silver tray measures 9-1/4" x 6"; the glass cruets are 5-1/4" high and have a 6 oz. Capacity; brand name or equal swift and fisher 9763(set) |  |
| Set, Cruet w/Chrome Tray, 2 glass cruets only | 9925-01-459-9602 | PR | The silver tray measures 9-1/4" x 6"; the glass cruets are 5-1/4" high and have a 6 oz. Capacity; brand name or equal swift and fisher 8150-2 (cruets) |  |
| Set, Cruet w/Chrome Tray, chrome tray only | 9925-01-459-9714 | EA | The silver tray measures 9-1/4" x 6"; the glass cruets are 5-1/4" high and have a 6oz. Capacity; brand name or equal swift and fisher 9763-1 (tray) |  |
| Cup, Common, Gold | 9925-01-459-7320 | EA | Height 6-1/8"; cup diameter 3-1/4"; hold 10oz.; wisp finish; gold-tone; brand name or equal; Alviti Creations 612g |  |

| | | | | |
|--------------------------------|------------------|----|---|---|
| Font, Baptismal, Bronze | 9925-01-459-4015 | EA | Bronze font w/cross finial; 17" diameter; hand painted in full colors; height to basin is 36"; removable cover; stainless steel basin |  |
| Holder, Candle, Gold (wedding) | 9925-01-461-0664 | EA | Gold-tone holder is designed to hold large center candle and 2 tapers, one on each; to be used in conjunction with celebration of roses candles; brand name or equal; regal 1400g |  |
| Kit, Mass, Compact | 9925-01-459-8139 | KT | Canvas case with adjustable shoulder strap measures 15"h x 16"w x 8"d; includes a 4-3/4" chalice, ciborium, 2 cruets, altar crucifix, and votives; special features include padded compartment for wine bottle and several extra pockets inside and out; brand name or equal; Alviti Creations w596 |  |
| Ostensorium | 9925-01-459-7445 | EA | Height 22"; head diameter 11"; all metal construction; all gold and silver plated; cross design; equipped with no track luma and pivoted door; brand name or equal Ziegler m- 820 |  |
| Paten, Bowl | 9925-01-459-7256 | EA | 6-1/4" diameter; 24 kt. Gold plated; bright polished inside finish; brand name or equal; Ziegler co. 4913 |  |

| | | | | |
|-----------------------------|------------------|----|--|---|
| Plate, Collection | 9925-01-459-3717 | EA | chrome plate with plain blue pad; 12 x 12; 3lbs |  |
| Plates, Collection, Brass | 9925-01-460-0231 | EA | Made of solid brass; 12"x12"; 3lbs.; plain white pad; brand name or equal; artistic church ware rw-120 |  |
| Pot, Holy Water w/Sprinkler | 9925-01-460-0102 | EA | Made of bronze; satin finish holy water pot with satin finish sprinkler and liner; brand name or equal; regal 26-ps-10 |  |
| Pyx, Large | 9925-01-459-7492 | EA | Gold color; lamb on front; host capacity; 60 (based on 1-1/8" host); 3-1/4" diameter x 1"h; brand name or equal; Koley k-160 |  |
| Pyx, Medium | 9925-01-459-7477 | EA | Gold color; cross and IHS inscribed on front; host capacity; 70 (based on 1-1/8" host); 2- 1/4" diameter x 1-3/4" h; brand name or equal; Elizabeth Ind. 95019 |  |
| Receptacle, Holy Water, 5G | 9925-01-459-8056 | EA | 5 gallon capacity stainless steel tank; height 41"; leg spread 16"; steel stand, hammer tone silver finish; brand name or equal; Koley k445 |  |

| | | | | |
|----------------------------|------------------|----|--|---|
| Receptacle, Holy Water, 6G | 9925-01-459-8103 | EA | 6 gallon stainless steel tank; antique brown, steel base and column; height 46"; base diameter 14"; push button faucet; clear plastic drip basin; brand name or equal: regal 36 dwh 15 |  |
| Set, Baptismal | 9925-01-459-9573 | SE | Three piece silver baptismal set with oil stocks and cotton container in black leatherette case; brand name or equal; Koley k-34 |  |
| Set, Censer, Bronze | 9925-01-459-3676 | SE | Bronze satin finish; oven baked for durability; Excelsis no.1100-123 or equal |  |
| Set, Home Sick Call | 9925-01-460-0098 | SE | Black case measures 6" x 4" x 1"; contents include cross with corpus, 2 candles, holy water container, and white cloth; brand name or equal; swift and fisher 7319 |  |
| Set, Pastoral | 9925-01-459-9473 | SE | Contents of kit include: stainless steel chalice and paten, oil stock, sprinkler and host box, removable tray for candles, gold plated spoon and bottle, crucifix included with corpus; case size 8"x0=3/4"x2-1/2" |  |
| Set, Sacristy Oil | 9925-01-459-9576 | SE | Three aluminum containers (o1,os,sc) contained in a black case which measures 5- 1/2" x 3-3/4"; brand name or equal; Koley k-39 |  |



| | | | | |
|-----------------------|------------------|----|--|---|
| Shell, Baptismal | 9925-01-459-8050 | EA | Heavy cast pewter; double gold plated and finished in 24k gold plate; 4" diameter; 3 feet provide stability; brand name or equal: swift and fisher 8960g |  |
| Stand, Bible, Brass | 9925-01-459-3799 | EA | Highly polished brass finish; height 6"; base 7" diameter; bookrest: 15" width, 12" depth; regal no.23 ms 23 or equal |  |
| Stand, Censer | 9925-01-088-7614 | EA | Satin bronze finish; 46 in. H; 10.250 in. Base dia; 4.875 in. Boat holder dia; 7.750 in. Bucket holder dia |  |
| Stations of the Cross | 9925-01-459-3784 | EA | wooden stations of the cross series in genuine florentine gold leaf with laminated full color lithographs; 20high; entire set of 14; |  |
| Tabernacle, Aluminum | 9925-01-459-7113 | EA | Base 15-1/2" wide, top 13" wide, height 9", depth 9", door 6-3/4" x 7-1/2" high; satin finish, cross on front is bright brass; white interior; brand name or equal; Koley k334 |  |

| | | | | |
|---|------------------|----|---|---|
| Tongs, Charcoal | 9925-01-459-3431 | EA | 10" charcoal tongs; black steel; Ziegler co. Charcoal tongs or equal |  |
| Vase, with liner, 5 x 10, polished brass | 9925-01-459-3693 | PR | Polished brass finish, base 5 inch by 10 inch height |  |
| Vase, with liner, 5 x 10, satin brass | 9925-01-459-3664 | PR | Satin brass finish, base 5 inch by 10 inch height |  |
| Vase, with liner, 6 x 12, polished brass | 9925-01-459-3666 | PR | Polished brass finish, base 6 inch by 12 inch height |  |
| Vase, with liner, 6 x 12, satin brass | 9925-01-459-3699 | PR | Satin brass finish, base 6 inch by 12 inch height |  |

| | | | | |
|---|-------------------------|-----------|--|---|
| <p>Wreath, Advent, Tabletop</p> | <p>9925-01-461-0665</p> | <p>EA</p> | <p>Gold-tone material is polished to a high luster and protected by an exclusive urethane finish; single ring, 5-light candelabra; holds center candle with a 3-1/2" diameter base; 1-1/2" advent candle socket; 8" high x 23"; 12 lbs.; brand name or equal; artistic rw-1380</p> |  |
| This area is intentionally left blank in the original image | | | | |



Seasonal Items/Special Ordering Timelines May Apply

[Table of Contents](#)



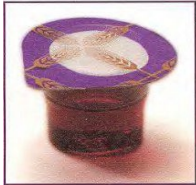
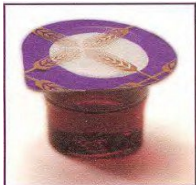

| | | | | |
|------------------------------------|------------------|----|--|---|
| Ashes, Palm | 9925-01-459-8149 | OZ | Palm ashes for ash Wednesday; 1oz. Enough for 250 people; brand name or equal; Paulist Press Ordos 06-52091 |  |
| Orthodox Palm Leaves, Double Strip | 9925-01-530-1543 | HD | For Orthodox Christian use only; fresh Florida palm; stripped double, palm leaves; 24 inches - 42 inches long |  |
| Orthodox Leaves, Fan | 9925-01-530-0609 | BG | For orthodox Christian use only; fresh Florida palm; packed 4 to a bag; 24 inches to 36 inches |  |
| Palm Leaves, Double, Strip | 9925-01-459-8041 | HD | Fresh Florida palm; stripped double palm leaves; 24" - 42" long; sold only in multiples of 100; brand name or equal tally's providence palm dealers 29-24429 |  |





| | | | | |
|------------------|------------------|----|--|---|
| Palm Leaves, Fan | 9925-01-459-8155 | BG | Fresh Florida palm; packed 4 to a bag; 24" to 36"; brand name or equal; tally's providence palm dealers 29-24369 |  |
| | | | | |



Communion Supplies

| | | | | |
|--|-------------------------|-----------|--|---|
| <p>Host and Juice Set, 500/box</p> | <p>9925-01-460-2220</p> | <p>BX</p> | <p>Cj0500b 500/box small, plastic individual communion cup (standard size) filled with grape juice, packaged with a small host sealed on top; cup uses hygienic, purity-sealed packaging; each package will have its own NSN; brand name or equal; Compak International, Inc.'s Celebration Cup™</p> |  |
| <p>Host and Juice Set, 60/box</p> | <p>9925-01-460-2276</p> | <p>BX</p> | <p>Cj0060b 60/box small, plastic individual communion cup (standard size) filled with grape juice, packaged with a small host sealed on top; cup uses hygienic, purity-sealed packaging; each package will have its own NSN; brand name or equal; Compak International, Inc.'s Celebration Cup™</p> |  |
| <p>Host, 1", Rice, Gluten Free</p> | <p>9925-01-708-9701</p> | <p>BX</p> | <p>1" diameter; standard thickness; 1000/box; Gluten Free</p> |  |
| <p>Host, 1 1/8", wheat</p> | <p>9925-01-459-7518</p> | <p>MX</p> | <p>1-1/8" diameter; standard thickness; 1000/box; cross inscribed in center</p> |  |



| | | | | |
|-------------------------------|------------------|----|--|---|
| Host, 1 1/8", white | 9925-01-459-7998 | MX | 1-1/8" diameter; standard thickness; 1000/box; cross inscribed in center |  |
| Host, 2 3/4", wheat | 9925-01-353-9312 | CO | 2-3/4" diameter; 50/package; packaged to maintain freshness |  |
| Host 2 3/4", white | 9925-01-460-1088 | CO | 2-3/4" diameter; 50/package; packaged to maintain freshness |  |
| Host, 5-3/4", wheat | 9925-01-567-8726 | BX | 5-3/4" diameter; 25/package; packaged to maintain freshness |  |
| Host, Double Thick | 9925-01-466-4747 | MX | -3/8 inch diameter, double thick, pure wheat flour, Cavanagh altar bread, number 138dt or equal |  |
| Cup, Communion, Individual | 9925-01-232-8992 | MX | Plastic disposable cups, Packaged in box (1000 each box); One-Piece; Depth 1.375 Inches, Top Diameter 1.187 Inches; Edge Type: Rolled; Color: Clear Plastic |  |





| | | | | |
|---|------------------|----|---|---|
| Juice, Grape, Sacred, Bottled | 9925-01-460-3050 | BX | Juice, grape, bottled, concord type or a blend of not more than less than 6% concord type and not more than 40% red grape varieties other than concord type, single strength, unsweetened, us grade a or us grade a equivalent, 48oz. Bottle, US Standards, type i or iii, style i or ii; 6 bottles to a box |  |
| Juice, Grape, Sacred, Canned | 9925-01-451-4908 | CN | Canned; concord type or a blend of not less than 60 percent concord type and not more than 40 percent red grape varieties other than concord type, single strength, unsweetened, US grade A or US grade A equivalent, 5-1/4 to 6 fluid oz. (155.264 to 177.444 ml) can, US Standards for grades, type i or iii, style i or ii; component of chaplain's kit, consumable (9925 01-326-2855) |  |
| Wine, Sacramental, 1887 ml, Anglican Port | 9925-01-706-2736 | BX | California Altar Wine; Port Wine-18% Alcohol By Volume; Sweet Flavor, Rich In Bouquet; 24 bottles to a case; to be sold by the case |  |
| Wine, Sacramental, 187 ml, burgundy | 9925-01-460-2300 | BX | Wine, 12-14% alcohol by volume; 187 ml bottle, 24 bottles to a case; one NSN will be assigned to each variety as indicated below; to be sold by the case; red, full-bodied, dry |  |





| | | | | |
|--------------------------------------|------------------|----|--|---|
| Wine, Sacramental, 187 ml, Chablis | 9925-01-462-5988 | BX | Wine, 12-14% alcohol by volume; 187-ml bottle, 24 bottles to a case; to be sold by the case |  |
| Wine, Sacramental, 750 ml, burgundy | 9925-01-459-8045 | BX | Wine 12-14% alcohol by volume; 750 ml bottle; 12 bottles per case; one NSN for each variety; dozen; red, full bodied, dry |  |
| Wine, Sacramental, 750 ml, Chablis | 9925-01-459-8011 | BX | Wine 12-14% alcohol by volume; 750 ml bottle; 12 bottles per case; one NSN for each variety; dozen; white, fresh, dry |  |
| Wine, Sacramental, 750 ml, Lt Muscat | 9925-01-465-5593 | BX | Light Muscat, 12% or more alcohol by volume, non-fortified, 750 ml bottle, 12/case, medium sweet, light amber, Cribari altar wine number 110342030 or equal |  |
| Wine, Sacramental, 750 ml, Lt Red | 9925-01-465-5695 | BX | Light red, 12% or more alcohol by volume, non-fortified, 750 ml bottle 12/case, most of the characteristics of Rosato, but red, not as sweet, Cribari altar wine number 110343032 or equal |  |

| | | | | |
|--|------------------|----|--|---|
| Wine, Sacramental, 750 ml, pink Rosato | 9925-01-465-5549 | BX | Rosato (pink), 12% or more alcohol by volume, non-fortified, 750 ml bottle, 12/case, quality reserve, mild sweet, Cribari altar wine number 110342034 or equal |  |
| Wine, Sacramental, 750 ml, Rosato | 9925-01-459-8055 | BX | Wine 12-14% alcohol by volume; 750 ml bottle; 12 bottles per case; one NSN for each variety; dozen; white, mild, sweet |  |
| | | | | |



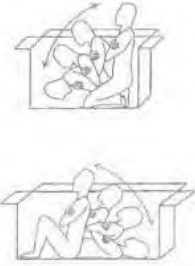

Field Items





| | | | | |
|---------------------------------|------------------|----|--|--|
| Altar, Portable | 9925-01-473-8705 | EA | Top of altar when extended is 28 in. X 60 in. X 0.100 in. Thick anodized aluminum; top has a satin like finish; welded corners; top folds in half for storage; each section is 28 in. X 30 in. with a 2 in lip on all sides; legs are 28 in long when not extended and 39 in. folding. Aluminum altar only |  |
| Altar, Portable w/Carrying Case | 9925-01-470-4115 | EA | Portable altar w/carrying case – item is portable altar and carrying case only |  |
| Altar, Portable, Complete | 9925-01-473-8867 | EA | Consists of altar with carrier, Fair linen altar covers hanging set, 4 each (red, purple, green, white) |  |



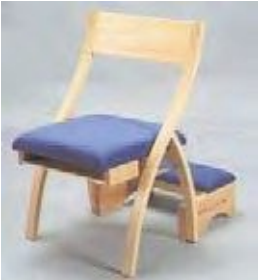

| | | | | |
|------------------------------------|------------------|----|--|---|
| Carrier, Portable Altar | 9925-01-473-8715 | EA | Carrier, portable altar, constructed from 1000 denier cordura duct material with urethane coating (waterproof), cover is od7(green) mil standard, external size is 29 inches top x 31 inches sides x 4-1/2 inches thick and will snugly contain the folded altar and linens when completely closed, two handles, adjustable shoulder strap |  |
| Cover, Elements, Portable Altar | 9925-01-470-4113 | EA | Portable altar elements cover – white, washable fabric to cover top of portable altar |  |
| Fair Linen, Portable Altar | 9925-01-470-4118 | EA | Portable altar fair linen – washable fabric which covers only top, left, and right sides of the altar |  |
| Hangings, Seasonal, Portable Altar | 9925-01-470-4116 | SE | Consists of altar hangings, 4 each (red, purple, green, white) |  |

| | | | | |
|------------------------------------|------------------|----|---|---|
| Field Immersion Baptismal Liner | 9925-01-450-0085 | EA | Disposable in-ground plastic liner that is large enough for the baptismal candidate to either sit or kneel; clear gusseted polyethylene bag; 4-mil thick; 36 inches wide; 72 inches long; 66 inches high |  |
| Pulpit, Field | 9925-01-470-4114 | EA | Field Pulpit – light oak with capability for attachment of seasonal hangings (not included) size estimated: 22”x14”x43” |  |
| Hangings, Seasonal, Field Pulpit | 9925-01-474-0822 | SE | Field pulpit seasonal hangings consist of: green, purple, red and white (qty.4) dimensions; 15” wide x 43” long. Each seasonal hanging will have the capability to attach to the back edge of field pulpit with one snap fastener and female snap fastener will attach to the seasonal hanging centered, ¾” from the top edge. Seasonal hangings will be plain, with no symbols and will be constructed from easy care, washable fabric, hemmed on all sides. Used with Field Pulpit NSN 9925-01-470-4114 |  |
| Sacramental Linens, Portable Altar | 9925-01-470-4127 | SE | This sacramental linen set consists of 4 pieces; they include Purificator, Lavabo Towel, Pall w/Insert, and Corporal; white w/red cross; |  |





Furniture





| | | | | |
|---------------------------|------------------|----|---|---|
| Altar | 9925-01-459-5072 | EA | Combination of veneer or solid oak finished in Enduracote iii; finishes: light, medium, dark, limed, drift, walnut, pecan; 40”h x 72”w x 30” d; 200 lbs.; brass symbol on front |  |
| Altar, Gothic Traditional | 9925-01-459-3803 | EA | Combination of sliced red oak plywood and solid red oak; finished in Enduracote iii; 40”h x 72”w x 33” d; 325 lbs.; brass wheat, grapes and fish on front; finishes: light, medium, dark, limed, drift, walnut, pecan |  |
| Altar, Modern Grouping | 9925-01-459-3832 | EA | Combination of sliced red oak plywood and solid red oak; finished in Enduracote iii; 40”h x 72”w x 30” d; 225 lbs.; comes with cast brass symbol of fish (8” x 2-1/2”), grapes (5” x 4-1/2”), and wheat ((14” x 7-1/2”); finishes: light, medium, dark, limed, drift, walnut, pecan |  |
| Board, Hymnal, Dark Oak | 9925-01-459-3713 | EA | Dark oak finish; durable oak laminated on both sides of 3/4" Fibercore; finished on both sides; cross routed at top in gold gilding; complete with slide "hymns" and four sets of numerals 0-9; 11-1/2" x 24" overall; shipping wt. 6 lbs. 12ozs; rectangular shape with rounded top; |  |





| | | | | |
|-------------------------------|------------------|----|---|---|
| Board, Hymnal, Light Oak | 9925-01-459-4007 | EA | Light oak finish; durable oak laminated on both sides of 3/4" Fibercore; finished on both sides; cross routed at top in gold gilding; complete with slide "hymns" and four sets of numerals 0-9; 11-1/2" x 24" overall; shipping wt. 6 lbs. 12ozs; rectangular shape with rounded top; |  |
| Chair, Folding with Prie Dieu | 9925-01-459-3849 | EA | Combination of sliced red oak plywood and solid red oak finished in Enduracote iii; finishes: light, medium, dark, limed, drift, walnut, pecan; open 33"h x 21"w x 20"d; 20 lbs.; upholstered kneeler and seat in the following: cardinal red, red, raspberry, port, spectrum blue, indigo, dark green, gold, grey, blue, teal, maple sugar, earth; book rack under seat; wood back |  |
| Chair, Interlocking, 1-20 | 9925-01-465-5723 | EA | Chair interlocking, under seat bookrack and cup holder, radius interlock, 1-20 chairs. |  |
| Chair, Interlocking, 21-74 | 9925-01-465-5726 | EA | Chair interlocking, under seat bookrack and cup holder, radius interlock, 21-74 chairs. |  |
| Chair, Interlocking, 75-299 | 9925-01-465-5729 | EA | Chair interlocking, under seat bookrack and cup holder, radius interlock, 75-299 chairs. |  |





| | | | | |
|---------------------------------------|------------------|----|---|---|
| Chair, Interlocking, 300+ | 9925-01-465-5752 | EA | Chair interlocking, under seat bookrack and cup holder, radius interlock, 300+ chairs. |  |
| Chair, Non-Stacking Armless | 9925-01-459-3836 | EA | Combination of sliced red oak plywood and solid red oak finished in Enduracote iii(catalyzed locked in durability); finishes: light, medium, dark, limed, drift, walnut, pecan; 31"h x 21"w x 19"d; 22lbs.; upholstered back and seat in the following: cardinal red, red, raspberry, port, spectrum blue, indigo, dark green, gold, grey, blue, teal, maple sugar, earth; book rack under seat |  |
| Chair, Non-Stacking, w/Arms | 9925-01-459-3845 | EA | Combination of sliced red oak plywood and solid red oak finished in Enduracote iii(catalyzed locked in durability); finishes: light, medium, dark, limed, drift, walnut, pecan; 27"h x 21"w x 19"d; 25lbs.; upholstered back and seat in the following: cardinal red, red, raspberry, port, spectrum blue, indigo, dark green, gold, grey, blue, teal, maple sugar, earth; book rack under seat |  |
| Chair, Sanctuary w/Arms, Contemporary | 9925-01-459-2077 | EA | Veneer or solid oak plywood and solid red oak finished in Enduracote iii; finishes: light, medium, dark, limed, drift, walnut, pecan; 36"h x 27"w x 18"d; 50lbs.; cross carved in front and back; upholstered back and seat in the following: cardinal red, red, raspberry, port, spectrum blue, indigo, dark green, gold, grey, blue, teal, maple sugar, earth; |  |

| | | | | |
|-------------------------------------|------------------|----|---|---|
| Chair, Sanctuary, Contemporary | 9925-01-459-4133 | EA | Veneer or solid oak plywood and solid red oak finished in Enduracote iii; finishes: light, medium, dark, limed, drift, walnut, pecan; 34"h x 21"w x 16"d; cross carved in front and back; upholstered back and seat in the following: cardinal red, red, raspberry, port, spectrum blue, indigo, dark green, gold, grey, blue, teal, maple sugar, earth; |  |
| Chair, Stacking | 9925-01-459-3859 | EA | Combination of sliced red oak plywood and solid red oak finished in Enduracote iii(catalyzed locked in durability); finishes: light, medium, dark, limed, drift, walnut, pecan; 33"h x 20"w x 18"d; 25lbs.; upholstered back and seat in the following: cardinal red, red, raspberry, port, spectrum blue, indigo, dark green, gold, grey, blue, teal, maple sugar, earth; book rack under seat |  |
| Communion Table, Gothic Traditional | 9925-01-459-3827 | EA | Combination of sliced red oak plywood and solid red oak; finished in Enduracote iii; 60"w x 40"h x 32"d; 300 lbs.; "this do in remembrance of me" carved on front; can be used as an altar; finishes: light, medium, dark, limed, drift, walnut, pecan |  |
| Communion Table, Traditional | 9925-01-459-4052 | EA | Medium wood finish; "in remembrance of me" inscribed on front; 21" x 48" x 30"h; 65lbs |  |
| Font, baptismal, Gothic Traditional | 9925-01-459-5476 | EA | Combination of sliced red oak plywood and solid red oak; finished in Enduracote iii; finishes: light, medium, dark, limed, drift, walnut, pecan; swivel top w/cross on top; 51"h x 21"w x 21"d; 75lbs |  |

| | | | | |
|-------------------------------------|------------------|----|---|---|
| Lectern, Gothic Traditional | 9925-01-459-3817 | EA | Combination of sliced red oak plywood and solid red oak; finished in Enduracote iii; finishes: light, medium, dark, limed, drift, walnut, pecan; brass cross on front, lamp included; 45”h x 25”w x 20”d; 100lbs |  |
| Lectern, Modern Grouping | 9925-01-459-3782 | EA | Combination of sliced red oak plywood and solid red oak; finished in Enduracote iii; finishes: light, medium, dark, limed, drift, walnut, pecan; brass cross on front, has extended shelf for lamp (lamp included) and microphone; 45”h x 21”w x 20”d; 125lbs |  |
| Offertory Table, Gothic Traditional | 9925-01-459-3806 | EA | Combination of sliced red oak plywood and solid red oak; finished in Enduracote iii; finishes: light, medium, dark, limed, drift, walnut, pecan; brass cross on front; 30”h x 25”w x 19”d; 75lbs |  |
| Offertory Table, Modern Grouping | 9925-01-459-5534 | EA | Combination of sliced red oak plywood and solid red oak; finished in Enduracote iii; finishes: light, medium, dark, limed, drift, walnut, pecan; brass cross on front; open in back with one shelf; 30”h x 25”w x 16”d; 75lbs |  |
| Pew End with Support | 9925-01-460-1084 | EA | Combination of sliced red oak plywood and solid red oak; finished in Enduracote iii; finishes: light, medium, dark, limed, drift, walnut, pecan; 34”h x 72”w x 21”d; 20lbs per foot; |  |





| | | | | |
|--------------------------------------|------------------|----|--|---|
| Pew Kneeler | 9925-01-459-5056 | FT | Combination of sliced red oak plywood and solid red oak; finished in Enduracote iii; finishes: light, medium, dark, limed, drift, walnut, pecan; sold by the Foot; kneeler can be upholstered in: cardinal red, red, raspberry, port, spectrum blue, indigo, dark green, gold, grey, blue, teal, maple sugar, earth; w/metal screen; SOLD BY THE FOOT |  |
| Pew, Plain Seat and Back | 9925-01-459-3762 | FT | Plain seat and back; Combination of sliced red oak plywood and solid red oak; finished in Enduracote iii; finishes: light, medium, dark, limed, drift, walnut, pecan; sold by the Foot |  |
| Pew, Upholstered Seat and Plain Back | 9925-01-459-3725 | FT | Upholstered seat and plain back; Combination of sliced red oak plywood and solid red oak; finished in Enduracote iii; finishes: light, medium, dark, limed, drift, walnut, pecan; sold by the Foot; seat and/or back upholstered in: cardinal red, red, raspberry, port, spectrum blue, indigo, dark green, gold, grey, blue, teal, maple sugar, earth; SOLD BY THE FOOT |  |
| Pew, Upholstered Seat and Back | 9925-01-459-3775 | FT | Upholstered seat and back; Combination of sliced red oak plywood and solid red oak; finished in Enduracote iii; finishes: light, medium, dark, limed, drift, walnut, pecan; sold by the Foot; seat and/or back upholstered in: cardinal red, red, raspberry, port, spectrum blue, indigo, dark green, gold, grey, blue, teal, maple sugar, earth; SOLD BY THE FOOT |  |





| | | | | |
|---------------------------------------|-------------------------|-----------|--|---|
| <p>Prie Dieu, Gothic Traditional</p> | <p>9925-01-459-4097</p> | <p>EA</p> | <p>Combination of sliced red oak plywood and solid red oak finished in Enduracote 111; 23" w x 34" h x 23" d; 75 lbs, brass cross on front; finishes available in light, medium, dark, limed, drift, walnut, pecan; upholstered kneeler in cardinal red, red, raspberry, port, spectrum blue, indigo, dark green, gold, grey, blue, teal, maple sugar, earth</p> |  |
| <p>Prie Dieu, Modern Grouping</p> | <p>9925-01-459-3767</p> | <p>EA</p> | <p>Combination of sliced red oak plywood and solid red oak finished in Enduracote 111; 22" w x 34" h x 18" d; 70 lbs, 8" cast brass cross on front; finishes available in light, medium, dark, limed, drift, walnut, pecan; upholstered kneeler in cardinal red, red, raspberry, port, spectrum blue, indigo, dark green, gold, grey, blue, teal, maple sugar, earth</p> |  |
| <p>Prie Dieu, w/Stationary Screen</p> | <p>9925-01-459-3842</p> | <p>EA</p> | <p>Combination of sliced red oak plywood and solid red oak finished in Enduracote 111; 22" w x 52" h; 30 lbs, brass cross on front; finishes available in light, medium, dark, limed, drift, walnut, pecan; upholstered kneeler in cardinal red, red, raspberry, port, spectrum blue, indigo, dark green, gold, grey, blue, teal, maple sugar, earth</p> |  |
| <p>Pulpit, Gothic Traditional</p> | <p>9925-01-459-3790</p> | <p>EA</p> | <p>Combination of sliced red oak plywood and solid red oak finished in Enduracote 111; 36" w x 45" h x 24" d; 125 lbs, brass cross on front; lamp included; finishes available in light, medium, dark, limed, drift, walnut, pecan</p> |  |

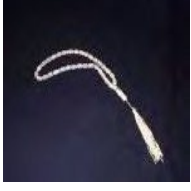

| | | | | |
|----------------------------------|------------------|----|--|--|
| Pulpit, Modern Grouping | 9925-01-459-3773 | EA | Combination of sliced red oak plywood and solid red oak finished in Enduracote 111; 30" w x 45" h x 20" d; 125 lbs, 16" cast brass cross on front; extended shelf for lamp (lamp included) and microphone; finishes available in light, medium, dark, limed, drift, walnut, pecan; |  |
| Rack, Pamphlet | 9925-01-460-0222 | EA | Constructed with a combination of sliced red oak plywood and solid red oak finished in Enduracote 111 (catalyzed locked in durability); finishes available in light, medium, dark, limed, drift, walnut, pecan |  |
| Table, Credence, w/Brass Casters | 9925-01-459-5080 | EA | Top 24" w x 16" d x 30" h; includes brass casters; light, medium, and dark oak finishes |  |
| Table, Credence, w/Formica | 9925-01-459-3998 | EA | Formica top; one shelf; light, medium, dark oak finish; top 20" w x 13" d x 30" h |  |

Islamic Items





[Table of Contents](#)

| | | | | |
|----------------------------------|------------------|----|--|---|
| Chaplain's Kit, Islamic | 9925-01-464-8618 | KT | For Muslim Chaplains |  |
| Chaplain's Kit, Islamic, Min Ext | 9925-01-464-8683 | KT | For Muslim Lay Leaders |  |
| Dhikr Prayer Beads, Black | 9925-01-464-9258 | EA | Dhikr prayer beads, black: n/cotton cord, color black, size not to exceed 14 inches |  |
| Dhikr Prayer Beads, White | 9925-01-464-9442 | EA | Dhikr prayer beads, white: n/cotton cord, color - white, size - not to exceed 14 inches |  |
| Crescent & Star | 9925-01-542-8938 | EA | Material is a 3.32 inch non-magnetic/reactive 304 stainless steel; plain polished; size is 1 inch by 1 inch wide |  |



| | | | | |
|----------------------------|------------------|----|---|---|
| Clock/Compass, Prayer | 9925-01-464-9303 | EA | Clock/compass prayer; digital display, includes protective case, clock/compass is able to be set for alarm notification of prayer times |  |
| Compass, Kiblah | 9925-01-464-9450 | EA | Prayer compass that points to al-Kaaba, diameter is approx. 1 3/4" with a black plastic shell and nap top, compass includes instruction booklet for use |  |
| Miswak | 9925-01-464-9434 | EA | 6 inch long Miswick stick, genuine Arak tree Siwak, individually wrapped in cellophane, natural flavor |  |
| Oil, Prayer, Egyptian Musk | 9925-01-464-9255 | CO | Oil, prayer, Egyptian musk; oil, non-alcoholic, 1/3 ounce leak-proof container |  |
| Oil, Prayer, Sandalwood | 9925-01-464-9244 | CO | Oil, prayer, sandalwood; oil, non-alcoholic, 1/3 ounce leak-proof container |  |

| | | | | |
|----------------|------------------|----|---|---|
| Prayer Rug OCP | 9925-01-672-5042 | EA | 100% cotton prayer rug w/pouch; used to ensure the sanctity and cleanliness of the place of prayer. OCP on one side, black/brown on the other |  |
| Dates, Dried | 9925-01-464-9465 | EA | Package of dried date pieces, us grade c, 8-12 oz (226.8g to 340.2g) package |  |
| | | | | |

Books and Literature

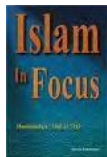
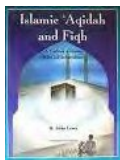
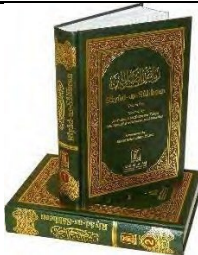
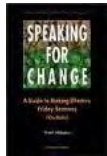
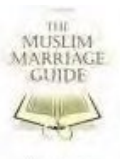

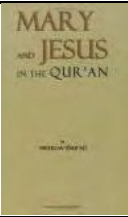
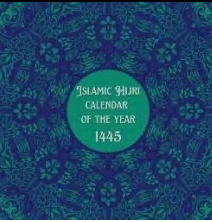

| | | | | |
|---------------------------------------|-------------------------|-----------|---|---|
| <p>Book, An-Nawawi's Forty Hadith</p> | <p>9925-01-464-9438</p> | <p>EA</p> | <p>ISBN 0933511221-an-nawawi's forty hadith Qudsi by Exxeddin Ibrahim And Denys Johnson-Davies, published Kazi publications, paperback, dimensions(in inches) 5.5 x 8.5</p> |  |
| <p>Book, Du'a</p> | <p>9925-01-464-9234</p> | <p>EA</p> | <p>Book, Du'a: ISBN 9960315711 - Du'a book entitled fortification of the Muslim through remembrance and supplication from the Qur'an and the Sunnah by Ismael Ibraheem, published by Dar-us Salem Riyadh, paperback dimensions(in inches) 3.25 x 4.75</p> |  |
| <p>Book, Forty Hadith Qudsi</p> | <p>9925-01-464-9436</p> | <p>EA</p> | <p>Book, forty Hadith Quudsi: ies, published Kazi publications, paperback, dimensions (in inches) 5.5 x 8.5</p> |  |
| <p>Book, Holy Qur'an</p> | <p>9925-01-353-8791</p> | <p>EA</p> | <p>ISBN: 0-915957-55-8. Sacred book of the Muslims, recording in Arabic/English the revelations of Allah to Mohammed. Published by Amana Publications, size 4" X 6"</p> |  |



| | | | | |
|-----------------------------------|------------------|----|---|---|
| Book, Islam in Focus | 9925-01-497-9822 | EA | Book, Islam in Focus, general introduction to the basic teachings of Islam |  |
| Book, Islamic Aqidah & Fiqh | 9925-01-497-9933 | EA | Book, Islamic Aqidah and Fiqh, a helpful textbook for teaching concepts of belief |  |
| Book, Riyadh Us-Saleheen Vol I&II | 9925-01-497-9908 | EA | Book, Riyadh Us-Saleheen, a collection of hadith |  |
| Book, Speaking for Change | 9925-01-497-9817 | EA | Book, Speaking for Change, informative guide explaining the importance of the Friday called Khutbah |  |
| Book, The Muslim Marriage Guide | 9925-01-497-9902 | EA | Book, The Muslim Marriage Guide, a prized book that meets the need for a guide for Muslim couples, married or planning marriage |  |

| | | | | |
|---------------------------------|------------------|----|---|---|
| Book, The Story of Mary & Jesus | 9925-01-497-9899 | EA | Book, the story of Mary and Jesus, the reading of the nineteenth chapter of the Qur'an |  |
| Calendar, Hijrah | 9925-01-497-9896 | EA | Calendar, Hijrah, a calendar which features beautiful, full-color natural photos accompanied with qur'anic verse |  |
| CD, Juz'Amma Recitation | 9925-01-497-9880 | EA | Features cd set, Juz'Amma recitation, an audio presentation of the noble Qur'an, designed to aid the English listener, set includes two cd's. |  |
| | | | | |

Clothing

[Table of Contents](#)



| | | | | |
|---------------------|------------------|----|--|---|
| Kimar, AG 489 | 9925-01-464-9443 | EA | Kimar, women's, head cover made from cotton or cotton blend. Size – 42"x42", color AG 489 (refers to army green 489) Kimar should be washable and color fast |  |
| Kimar, Black | 9925-01-452-7567 | EA | Kimar, women's head cover, either 100 percent lightweight cotton or a polyester/cotton mixture; centered stitched hood, pull-on; black (no embroidery); machine washable |  |
| Kimar, White | 9925-01-464-9444 | EA | Kimar, women's, head cover made from cotton or cotton blend. Size – 42"x42", color white, Kimar should be washable and color fast |  |
| Kufi, Men's, AG 489 | 9925-01-464-9447 | EA | Kufi, men's AG 489 made from 100% cotton stretch crochet, approx., 18" around, color AG 489, kufi should be washable and color fast |  |

| | | | | |
|-------------------|------------------|----|---|---|
| Kufi, Men's Black | 9925-01-464-9455 | EA | Kufi, men's, black made from 100% cotton stretch crochet, approx. 18" around, color black, kufi should be washable and color fast |  |
| Kufi, Men's White | 9925-01-464-9440 | EA | Kufi, men's, white made from 100% cotton stretch crochet, approx. 18" around, color white, kufi should be washable and color fast |  |
| | | | | |

Jewish Items



[Table of Contents](#)



| | | | | |
|---------------------------|------------------|----|--|---|
| Chaplain's Kit, Jewish | 9925-01-326-2856 | KT | For Jewish Chaplains |  |
| Kiddush Cup | 9925-01-466-1074 | EA | Textured Kiddush Cup; silver plated; 6" |  |
| Kiddush Cup | 9925-01-538-2239 | EA | Sterling Silver; Approximately 3" height |  |
| Mezuzah Parchment | 9925-01-466-1055 | EA | Mezuzah Parchment. Size: 2.5" x 3" |  |

| | | | | |
|---------------------|------------------|----|---|---|
| Star of David | 9925-01-542-8784 | EA | 1" star, stainless steel |  |
| Yad (Torah Pointer) | 9925-01-538-2180 | EA | Made of Olive wood; pointer has metal tip; comes with chain |  |
| | | | | |

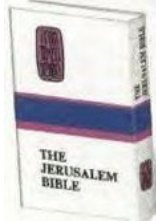
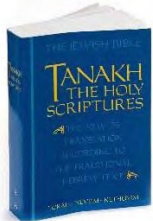

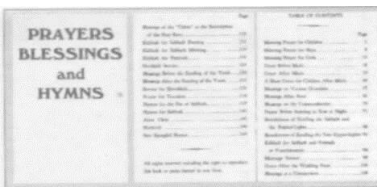

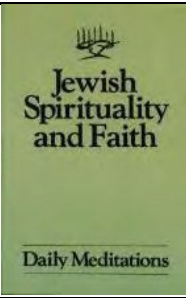
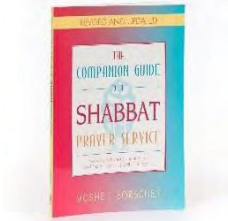
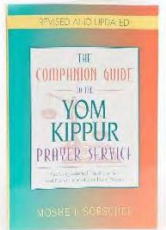
Books and Literature

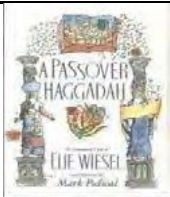
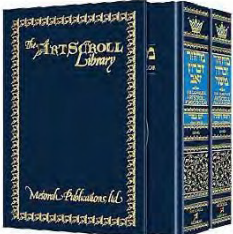

[Table of Contents](#)

| | | | | |
|---------------------------------|------------------|----|--|--|
| Bible, Jerusalem | 9925-01-465-9335 | EA | The Jerusalem Bible, Hebrew/English Tanakh published by Koren |  |
| Bible, Tanakh, paperback | 9925-01-465-9359 | EA | Tanakh: A New Translation of the Holy Scriptures According to the Traditional Hebrew Text. Size 7" x 5". |  |
| Book, Complete Artscroll Siddur | 9925-01-485-8272 | EA | Soft covered; size 4" X 6"; Hebrew/English; Footnotes. |  |
| Book, Jewish Prayers/Hymns | 9925-01-466-1512 | EA | Hardcover, KTAV Publishing House. 3 3/4" x 6" Contains traditional beshner w/ Eng. Translation. |  |

| | | | | |
|---------------------------|------------------|----|---|---|
| Book, Jewish Spirituality | 9925-01-486-3463 | EA | This item contains all the short meditations in the spirituality series. It replaces all four books |  |
| Book, Guide to Shabbat | 9925-01-466-1510 | EA | Companion Guide to the Shabbat Prayer Service by M. Sorscher & E. Simon. Paperback, ISBN 1880582198. |  |
| Book, Guide to Yom Kippur | 9925-01-466-1470 | EA | Comparison Guide to the Yom Kippur Prayer Service by M. Sorscher, K. Auman, and S. Sharfman. Paperback. |  |
| Book, Living Torah | 9925-01-536-9859 | EA | 5 Books of Torah with commentary, Hebrew/English |  |





| | | | | |
|--|------------------|----|--|---|
| Book, Living Torah | 9925-01-536-9861 | EA | 5 books of Torah with commentary; English only |  |
| Book, Psalms | 9925-01-465-9339 | EA | Book of Psalms: The New JPS Translation According to the Traditional Hebrew Text. Hardcover. Size 6" x 4". |  |
| Chumash, Book | 9925-01-536-9867 | EA | The Chumash: Stone Edition of the ArtScroll Chumash; ISBN: 0899060145 |  |
| Stone Edition of the Artscroll Chumash | 9925-01-538-4879 | EA | Chumash Stone Edition; Stone Edition of the Artscroll Chumash; ISBN: 0899060145 |  |
| Haggadah, Goldberg | 9925-01-466-1465 | EA | A New Annotated Passover Haggadah by Nathan Goldberg, paperback; ISBN 0870682164 |  |



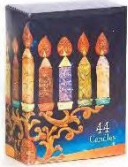

| | | | | |
|----------------------------|------------------|----|---|---|
| Haggadah, Wiesel | 9925-01-466-1467 | EA | A Passover Haggadah by Elie Wiesel; paperback; ISBN 0671799967 |  |
| Machzor, Artscroll | 9925-01-466-1514 | SE | Paperback mini version of the Artscroll Machzor |  |
| Siddur Sim Shalom | 9925-01-538-4875 | EA | Revised Siddur Sim Shalom; used for shabbat and festivals; revised edition; ISBN: 09162113S |  |
| Personal Siddur Sim Shalom | 9925-01-538-5035 | EA | Siddur Sim Shalom: Edition for personal use. |  |
| Siddur Sim Shalom | 9925-01-538-4878 | EA | Weekdays Siddur Sim Shalom; for Weekdays; ISBN: 0916214143 |  |

| | | | | |
|-----------------------|------------------|----|--|---|
| Torah Scroll | 9925-01-465-9306 | EA | Eighteen inch torah with velvet cover |  |
| Torah, Voweled Script | 9925-01-465-9309 | EA | Large size readable Torah script with vowels. One column for each Sidrah |  |
| | | | | |

Candles and Accessories



[Table of Contents](#)





| | | | | |
|--------------------------------|------------------|----|----------------------------------|---|
| Candle, Hanukah, Multi-colored | 9925-01-497-4384 | PG | Burn time ½ hour; 44 per package |  |
| Candle, Hanukah, Blue & White | 9925-01-497-4386 | PG | Burn time ½ hour; 44 per package |  |
| Candle, Hanukah, White | 9925-01-497-4389 | PG | Burn time ½ hour; 44 per package |  |
| Candle, Hanukah, Blue & White | 9925-01-497-4391 | PG | 7" tapered premium |  |





| | | | | |
|--------------------------|-------------------|----|---|---|
| Candle, Havdalah | 9925-01-466-1073 | EA | Beeswax 12" dripless candle intertwines six wicks. Sold as each |  |
| Candle, Memorial, Jewish | 9925-01-466-1059 | EA | Paraffin wax 3 oz. memorial candle |  |
| Candle, Shabbat | 99258-01-465-9330 | BX | Shabbat candles, box of 72 |  |
| Candle, Tealight | 9925-01-538-1811 | BG | White; comes in an aluminum cup, no holder necessary but may be used in a candle holder if preferred; 10 per bag; |  |
| Candlesticks, Traveling | 9925-01-466-1066 | PR | Traveling candlesticks are silver plated disc that divides into two compact candlesticks; size: 2.5" |  |



Clothing

[Table of Contents](#)





| | | | | |
|---------------------------|------------------|----|---|---|
| Yarmulke, Army (OCP) | 9925-01-673-0141 | EA | OCP yarmulke |  |
| Yarmulke, MARPAT Desert | 9925-01-534-8662 | EA | Marine Corps desert camouflage yarmulke |  |
| Yarmulke, MARPAT Woodland | 9925-01-534-8663 | EA | Marine Corps woodland camouflage yarmulke |  |

| | | | | |
|----------------------|------------------|----|---|---|
| Yarmulke, Black | 9925-01-465-9312 | EA | Black unlined yarmulke |  |
| Yarmulke, ABU | 9925-01-556-7319 | EA | Air Force ABU yarmulke |  |
| Tallit, Rayon, Black | 9925-01-465-9361 | EA | Rayon talism with black stripes, 18 x 72 inches |  |
| Tallit, Rayon, Blue | 9925-01-465-9360 | EA | Rayon talism with blue stripes, 18 x 72 inches |  |

| | | | | |
|-------------------------------|------------------|----|---|---|
| Tallit, Wool, size 70 | 9925-01-536-9442 | EA | Black Strips; non-slip; stain protection; size 70 5'8" – 5'10", Tallit 60"x80" |  |
| Tallit, Wool size 80 | 9925-01-536-9443 | EA | Black Strips; non-slip; stain protection; size 70 5'8" – 5'10", Tallit 60"x80" |  |
| Shawl, Prayer OCP size #55 | 9925-01-673-0282 | EA | Tallit OCP Size #55, for 5'2" – 5'4" |  |
| Shawl, Prayer OCP size #60 | 9925-01-673-0292 | EA | Tallit OCP Size #60, for 5'5" – 5'7" |  |
| Shawl, Prayer OCP size #70 | 9925-01-673-0379 | EA | Tallit OCP Size #70, for 5'8" – 5'10" |  |





| | | | | |
|---|-------------------------|-----------|--|---|
| <p>Shawl, Prayer OCP size #18 One size fits all</p> | <p>9925-01-673-0284</p> | <p>EA</p> | <p>Tallit OCP Size #18; one size fits all</p> |  |
| <p>Shawl, Prayer, OCP</p> | <p>9925-01-673-0367</p> | <p>EA</p> | <p>Tallit is OCP; 18" x 60"; Black Star of David embroidered onto each end of Tallit; Tzitzit fringes</p> |  |
| <p>Shawl, Prayer, OCP</p> | <p>9925-01-673-0359</p> | <p>EA</p> | <p>Tallit OCP; Black Star of David with tablets beneath star embroidered on to each end of tallit positioned 2 ½" from bottom of tallit, tablets centered beneath Star of David, Hebrew letters representing each of the 10 commandments</p> |  |
| Empty row | | | | |

| <div style="text-align: center;"><u>Seasonal Items</u></div> <div style="text-align: right; border: 1px solid black; padding: 2px;"> Table of Contents </div> | | | | |
|--|------------------|----|--|--|
| Four Species | 9925-01-488-9309 | SE | Includes Etrog, Lulav, Hadassim and Aravot Branches. Grade A and certified kosher. |  |
| Matzah Cover | 9925-01-466-1469 | EA | Multi-color printed matzah cover with pockets for three matzot |  |
| Menorah | 9925-01-465-9311 | EA | Heritage menorah, brass, 7.25 x 10 inches |  |

| | | | | |
|-------------------------------------|------------------|----|---|---|
| Seder, Leader (Rabbi) | 9925-01-526-3373 | KT | Contains various items for Passover with the first day's meal only. |  |
| Seder, Participant | 9925-01-526-3364 | KT | Contains various items for Passover with the first day's meal only. |  |
| Shofar | 9925-01-466-1507 | EA | Medium size shofar – 14 inches |  |
| Sukkah, (Succot) Portable, Small | 9925-01-532-0686 | EA | Succot, small; size 40" x 40" |  |
| Sukkah, (Succot) Portable, Large | 9925-01-532-0688 | EA | Succot, large; 7'2" x 7'2" |  |

Kosher Wine

[Table of Contents](#)

| | | | | |
|-------------------------------|------------------|----|---|---|
| Wine, Kosher, 750ml, Blush | 9925-01-465-9385 | DZ | 11% alc. By vol; 750 ml; Kosher for Passover. |  |
| Wine, Kosher, 750 ml, Concord | 9925-01-465-9365 | DZ | 11% alc. By vol; 750 ml; Kosher for Passover. |  |
| Wine, Kosher, 750 ml, Red | 9925-01-465-9388 | DZ | 11% alc. By vol; 750 ml; Kosher for Passover. |  |
| Wine, Kosher, 750 ml, White | 9925-01-465-9390 | DZ | 11% alc. By vol; 750 ml; Kosher for Passover. |  |

FAQ

How should I use this “catalog”?

This catalog should be used to view the current DLA managed Religious Supply National Stock Number (NSN) items. Use this catalog to review the correct NSN, verify the description of the item, and search FedMall using the NSN (without dashes).

Why is there no pricing information?

Due to a potential for fluctuations in pricing, please check the current prices at <https://www.fedmall.mil/index.html>

What is FedMall?

FedMall is an e-commerce ordering system for Department of Defense (DoD), Federal, State, and authorized local Agencies to search for and acquire products from government reserves and commercial sources.

How do I create a FedMall Account?

Start by visiting <http://www.dla.mil/Info/FedMall/FedMallBuyers/>

** You will need to know your Department of Defense Activity Address Code (DoDAAC). If you do not know this contact your local supply section.

What is a DoDAAC?

The Department of Defense Activity Address Code (DoDAAC) is a six-position code that uniquely identifies a Department of Defense unit, activity, or organization that has the authority to requisition, contract for, receive, have custody of, issue, or ship DoD assets, or fund/pay bills for materials and/or services. A DoDAAC contains your unit or activity’s billing and shipping address. More information.

Acquisition Advice Codes (AAC)

D – Centrally managed, stocked, and issued item. (Depot stocked)

H – Centrally managed and procured item. Direct delivery under a central contract number. (Vendor stocked)

J – Centrally managed but not stocked item. Procurement will be initiated only after receipt of a requisition.

I – Local purchase non-stocked item. Authorized for local purchase is as a normal means of support at base, post, camp, or station level.

R – Government furnished material (GFM). Items is centrally procured and stocked as GFM in connection with the manufacturer of military items. Base, post, camp, or stations will not requisition.

V – Terminal item. Item is in stock but future procurement is not authorized.

Y – Terminal item (non-stocked items). No wholesale stock is available for issue. Future procurement is not authorized.

Z – Numeric stockage objective item. Item required occasionally but requires a national quantity to be stocked due to the essentiality or the lead time of the item.