

Lightweight Maintenance Enclosure

[8340-01-456-3637 Lightweight Maintenance Enclosure \(LME\) Green](#)

[8340-01-507-4375 Lightweight Maintenance Enclosure \(LME\) Tan](#)

The Lightweight Maintenance Enclosure (LME) provides rapid deployment and forward maintenance elements without sacrificing mobility/survivability due to its light weight and ease of erection/strike. The LME can also be used as a cost effective general purpose tent. The tent features durable military specification design that is supported with spare parts in depot inventory.



KEY FEATURES:

- 768 square feet of floor area
- Complexible end to end
- 70 amp 120 volt power distribution panel
- General purpose string able four light set
- Provides blackout capability
- Lightweight, mobile repair shelter for tracked and wheeled vehicles
Across the battlefield under all climatic conditions

Description:

The LME is a frame supported lightweight shelter designed to provide units with a covered facility to conduct tactical maintenance operations. The LME is a modification of the Tent, Extendable, Modular, PERSONNEL (TEMPER) where extensions are added to the tent frame to add the height needed for enclosure of tactical vehicle and equipment. The end walls have been modified with sliding fabric doors permitting total enclosure during conditions of extreme weather or blackout. The LME has 18-inch diameter duct openings in each of the 16 ft. intermediate fabric sections located below the windows. The LME also has similar erect/strike procedures to the Temper which may reduce the training requirements. The LME is 24 feet wide, 32 feet long, 15 feet high (at the center), weighs 60% less than the current maintenance tent.



LME Tan System includes the following:

	NSN	DESCRIPTION	QUANTITY
1.	8340-01-507-4376	Fabric Assembly, Intermediate Panel, Tan	2
2.	8340-01-507-4378	Fabric Assembly, End Panel	2
3.	8340-01-475-8132	Frame Assembly Complete	1
4.	8340-01-475-8229	Repair Kit (part of find 8)	1
5.	8340-01-475-9504	Frame Transport Cover	4
6.	8340-01-475-9499	Frame Transport Cover	1
7.	8340-01-475-9860	Fabric Transport Cover	1
8.	8340-01-475-9864	Fabric Transport Cover / Repair Kit	1
9.	6110-01-475-8275	Bag, Power Distribution	1
10.	8340-01-475-9486	Tent Pin Bag	2
11.	8340-00-985-7461	Tent Pin, Steel, 18 in	20
12.	8340-00-261-9750	Tent Pin, Wood, 16 in.	50
13.	8340-00-261-9751	Tent Pin, Wood, 24 in.	26
14.	6230-01-465-8931	Light Assembly	4
15.	5340-01-475-8205	Light Support Strap. Assembly	4
16.	6120-01-475-8904	Power Distribution Box, 70 amp	1
17.	5925-01-271-6053	G.F.C.I. Receptacle, 20 amp, 120 volt ac (part of find 16)	4
18.	4010-01-476-0210	Guy Line w/Slip, Assembly, 23 foot	20
19.	4010-01-475-9502	Guy Line w/Slip, Assembly, 14 feet	24

The Technical Manual for this tent is TM 10-5410-284-13&P.



LME Green System includes the following:

	NSN	DESCRIPTION	QUANTITY
1.	8340-01-475-9490	Fabric Assembly, Intermediate Panel, Green	2
2.	8340-01-475-9495	Fabric Assembly, End Panel	2
3.	8340-01-475-8132	Frame Assembly Complete	1
4.	8340-01-475-8229	Repair Kit (part of find 8)	1
5.	8340-01-475-9504	Frame Transport Cover	4
6.	8340-01-475-9499	Frame Transport Cover	1
7.	8340-01-475-9860	Fabric Transport Cover	1
8.	8340-01-475-9864	Fabric Transport Cover / Repair Kit	1
9.	6110-01-475-8275	Bag, Power Distribution	1
10.	8340-01-475-9486	Tent Pin Bag	2
11.	8340-00-985-7461	Tent Pin, Steel, 18 in	20
12.	8340-00-261-9750	Tent Pin, Wood, 16 in.	50
13.	8340-00-261-9751	Tent Pin, Wood, 24 in.	26
14.	6230-01-465-8931	Light Assembly	4
15.	5340-01-475-8205	Light Support Strap. Assembly	4
16.	6120-01-475-8904	Power Distribution Box, 70 amp	1
17.	5925-01-271-6053	G.F.C.I. Receptacle, 20 amp, 120 volt ac (part of find 16)	4
18.	4010-01-476-0210	Guy Line w/Slip, Assembly, 23 foot	20
19.	4010-01-475-9502	Guy Line w/Slip, Assembly, 14 feet	24

PRODUCT SPECIFICATIONS:

- Dimensions: 32'Length X 24'Width X 15'6"Ridge Height and 12'Eave Height
- Floor Area: 768 square feet
- Weight: 1332 lbs. (1659 lbs. Packed)
- Set-up Time/# of Persons: 90/4
- Strike Time/# of Persons: 45/4
- Shipping Cube: 109 cubic feet

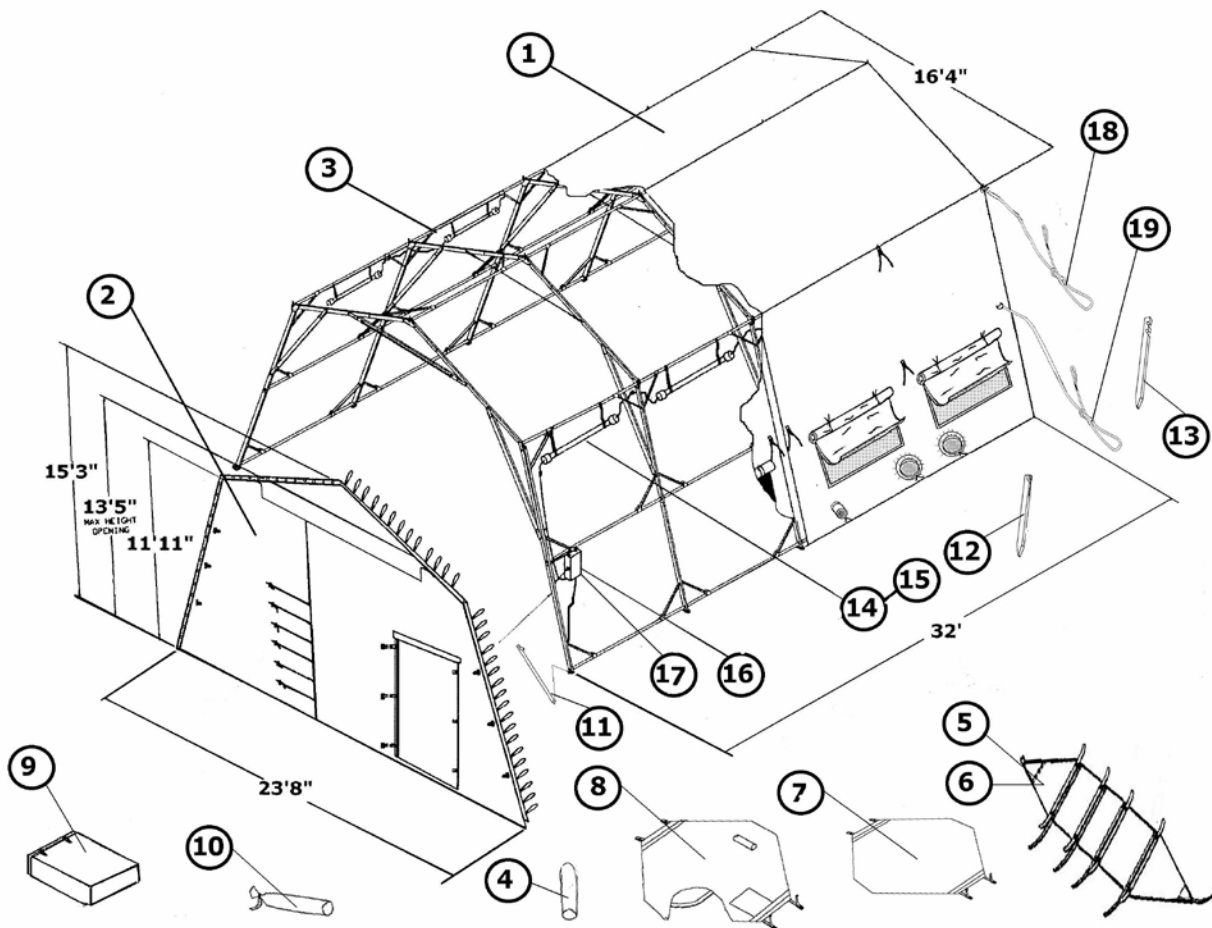

Cut-A-Way View		
Find #	NSN	Nomenclature
1.	8340-01-507-4376	Fabric Assembly, Intermediate Panel, Tan
2.	8340-01-507-4378	Fabric Assembly, End Panel
3.	8340-01-475-8132	Frame Assembly Complete
4.	8340-01-475-8229	Repair Kit (part of find 8)
5.	8340-01-475-9504	Frame Transport Cover
6.	8340-01-475-9499	Frame Transport Cover
7.	8340-01-475-9860	Fabric Transport Cover
8.	8340-01-475-9864	Fabric Transport Cover / Repair Kit
9.	6110-01-475-8275	Bag, Power Distribution
10.	8340-01-475-9486	Tent Pin Bag
11.	8340-00-985-7461	Tent Pin, Steel, 18 in
12.	8340-00-261-9750	Tent Pin, Wood, 16 in.
13.	8340-00-261-9751	Tent Pin, Wood, 24 in.
14.	6230-01-465-8931	Light Assembly
15.	5340-01-475-8205	Light Support Strap Assembly
16.	6120-01-475-8904	Power Distribution Box, 70 amp
17.	5925-01-271-6053	G.F.C.I. Receptacle, 20 amp, 120 volt ac (part of find 16)
18.	4010-01-476-0210	Guy Line w/Slip, Assembly, 23 foot
19.	4010-01-475-9502	Guy Line w/Slip, Assembly, 14 feet

Spare Parts & Options for the LME:

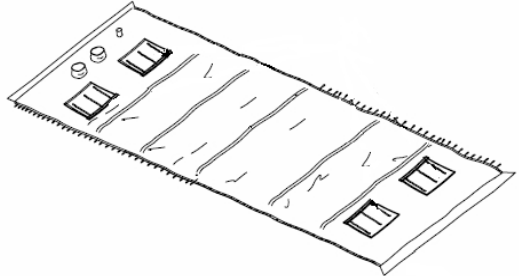
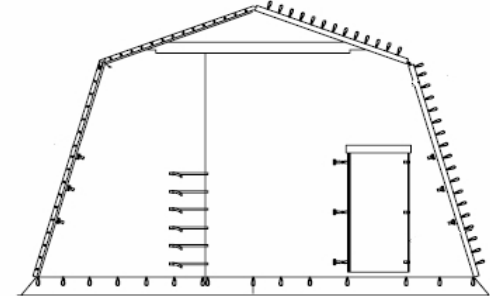
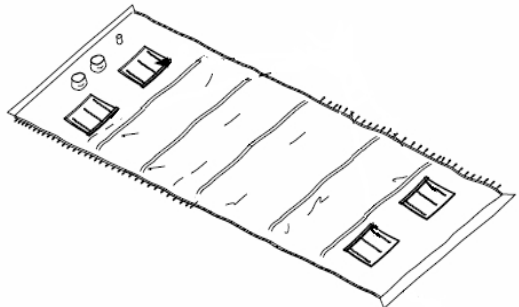
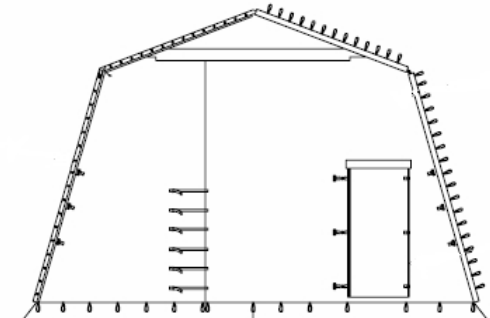
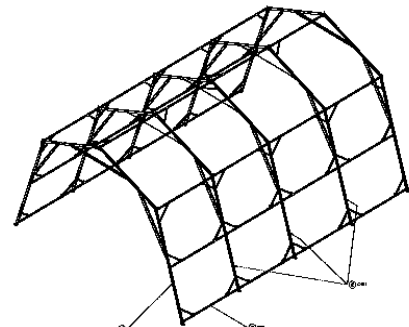
	NSN	DESCRIPTION	Photo
1.	8340-01-507-4376	Fabric Assembly, Intermediate Panel Lightweight Maintenance Enclosure - Tan	
2.	8340-01-507-4378	Fabric Assembly, End Panel Lightweight Maintenance Enclosure - Tan	
3.	8340-01-475-9490	Fabric Assembly, Intermediate Panel Lightweight Maintenance Enclosure – Green, 16' (note: there are 2 panels per tent as shown)	
4.	8340-01-475-9495	Fabric Assembly, End Panel Lightweight Maintenance Enclosure - Green	
5.	8340-01-475-8132	Frame Assembly Complete	

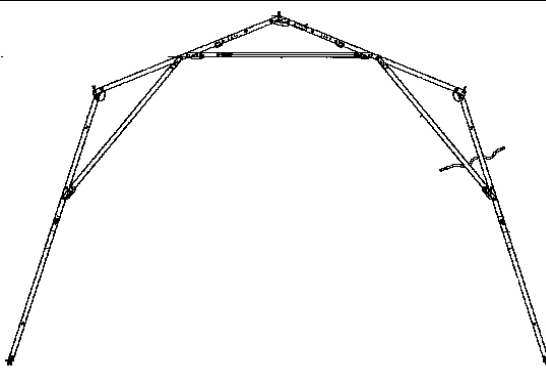
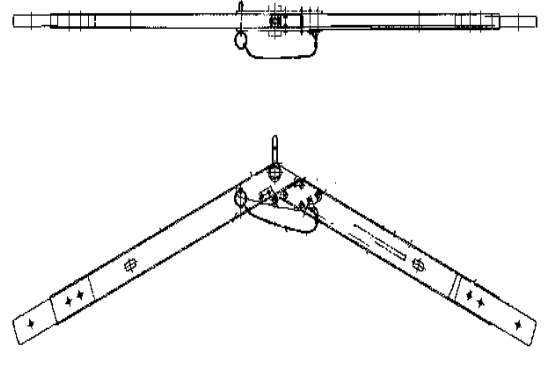
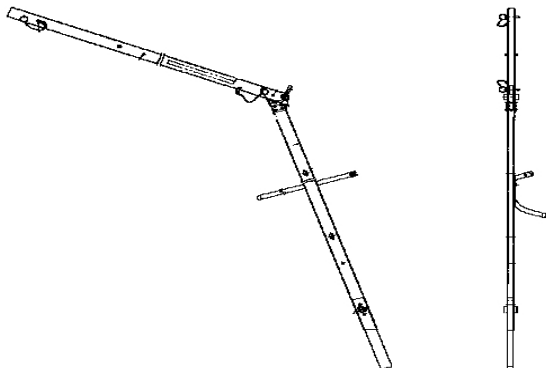
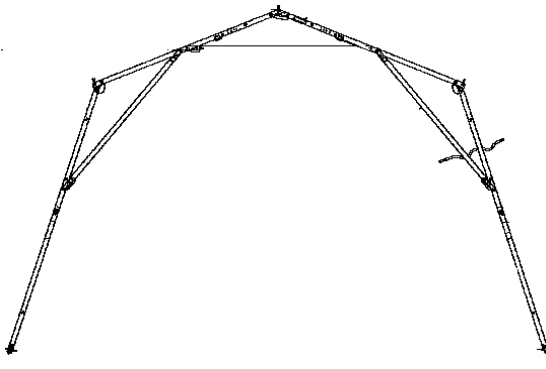
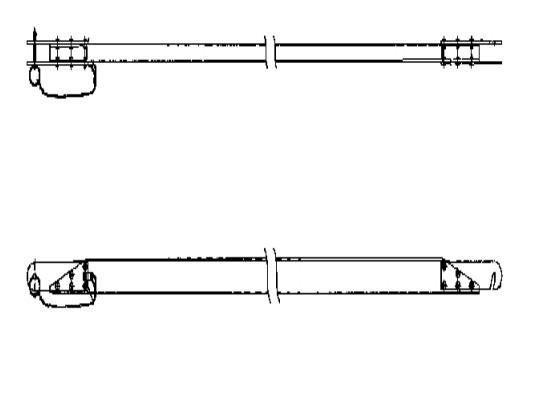
6.	8340-01-475-8150	Support, Tent Frame	
7.	8340-01-475-8152	Upper Arch Assembly, Frame	
8.	8340-01-475-8153	Lower Side Arch Assembly	
9.	8340-01-475-9279	Frame Assembly With Cable Header	
10.	8340-01-475-9509	Sider Assembly, Frame	

11. [8340-01-475-9530](#) Lower Leg Assembly, Frame

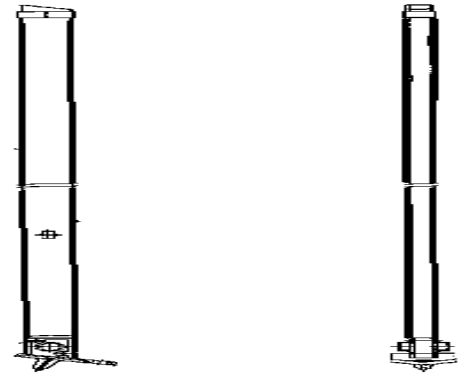

12. [8340-01-475-9648](#) Extension Assembly

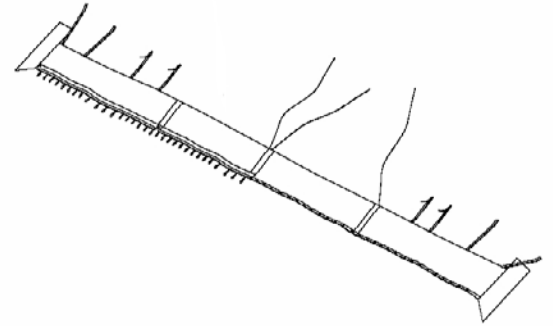

13. [8340-01-475-9651](#) Door Header Assembly

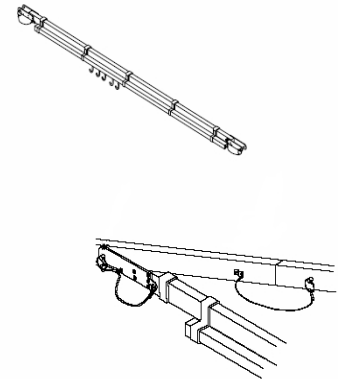

14. [8340-01-477-9657](#) Cable Header, Assembly

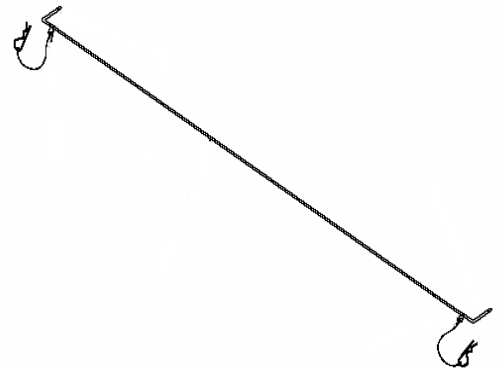

15. [8340-01-477-9709](#) Hitch Pin Clip, Assembly



16. [8340-01-475-9499](#) Frame Transport Cover

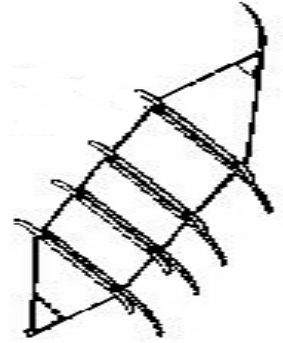

17. [8340-01-475-9504](#) Frame Transport Cover

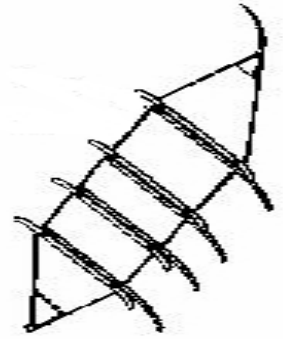

18. [8340-01-475-9860](#) Fabric Transport Cover

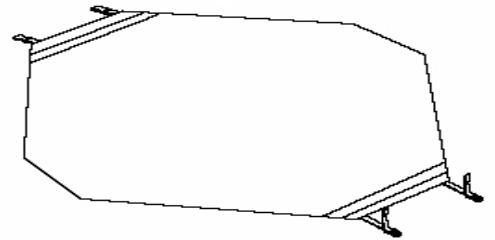

19. [8340-01-475-9864](#) Fabric Transport Cover/Repair Kit

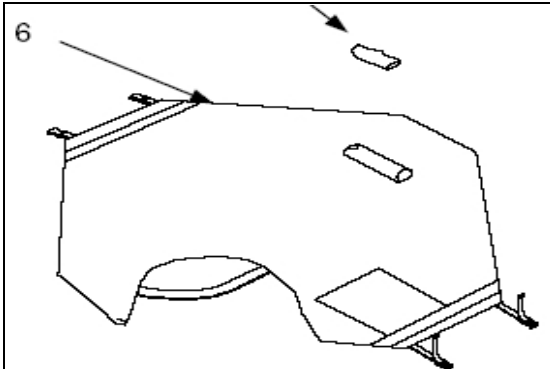

20. [8340-01-475-9486](#) Pin, Storage Bag



21. [8340-01-475-8229](#) Repair Kit

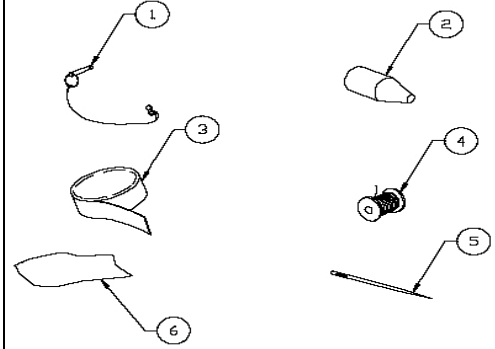

1. Pin, Quick Release, with Lanyard Assembly
2. Needle Pusher
3. Adhesive Tape 3" wide by 36" long Green
4. Adhesive Tape 3" wide by 36" long Tan
5. Thread Spool Green
6. Cloth, Duck, Green 36" by 60"
- Cloth, Duck, Tan 36" by 60"

22. [8340-00-985-7461](#) Tent Pin, Steel, 18"

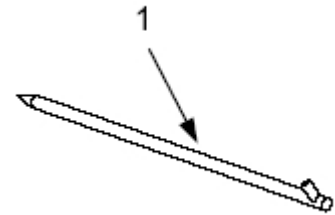

23. [8340-00-261-9750](#) Tent Pin, Wood, 16"



24. [8340-00-261-9751](#) Tent Pin, Wood, 24"

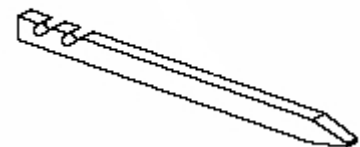

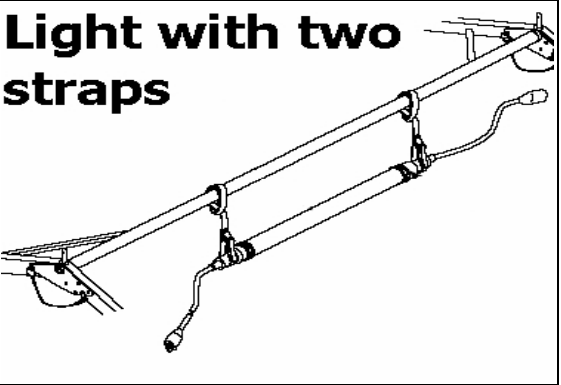
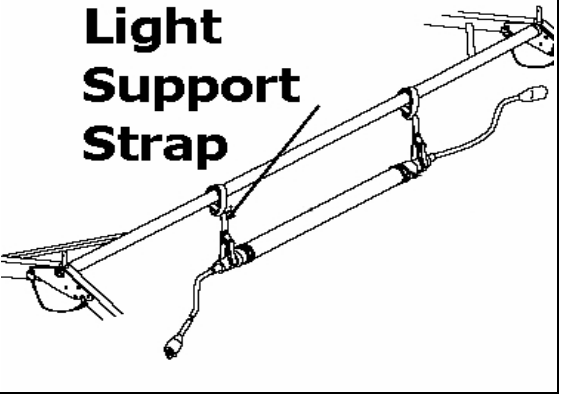
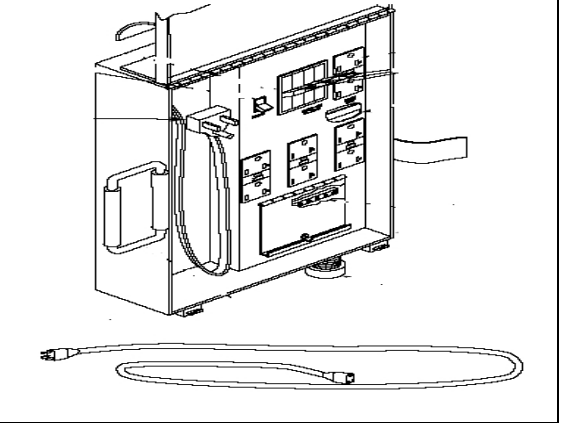
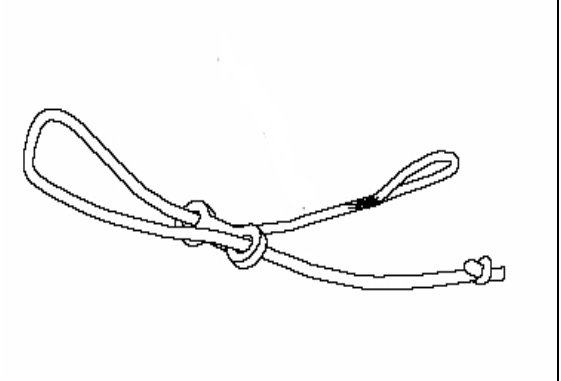
25.	6230-01-465-8931	Light Assembly	<p>Light with two straps</p> 
26	5430-01-475-8205	Light Support Strap, Assembly	<p>Light Support Strap</p> 
27.	6120-01-475-8904	Power Distribution Box, 70 amp	
28.	5925-01-271-6053	G.F.C.I. Receptacle, 20 amp, 120 volt ac	N/A
29.	4010-01-475-9502	Guy Line w/Slip, Assembly, 14 feet	

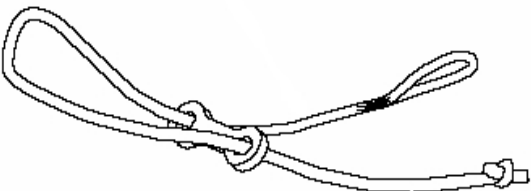
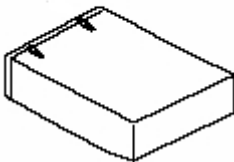
30.	4010-01-476-0210	Guy Line w/Slip, Assembly, 23 foot	
31.	6110-01-475-8275	Bag, Power Distribution	
32.	8340-01-186-3005	Purlin Assembly	